

RCA SCENIUM



HDTV/DVD Monitor User's Guide

Important Information

WARNING

To reduce the risk of fire or electric shock, do not expose this product to rain or moisture.

CAUTION

THIS PRODUCT UTILIZES A LASER. USE OF CONTROLS OR ADJUSTMENTS OR PERFORMANCE OF PROCEDURES OTHER THAN THOSE SPECIFIED HEREIN MAY RESULT IN HAZARDOUS RADIATION EXPOSURE. DO NOT OPEN COVERS AND DO NOT REPAIR YOURSELF. REFER SERVICING TO QUALIFIED PERSONNEL.

Note:

This DVD player is designed and manufactured to respond to the Region Management Information. If the Region number of a DVD disc does not correspond to the Region number of this DVD player, this DVD player cannot play the disc. The Region number for this DVD player is Region No 1.

**CLASS 1
LASER
PRODUCT**

CAUTION

RISK OF ELECTRIC SHOCK DO NOT OPEN



This symbol indicates that this product incorporates double insulation between hazardous mains voltage and user accessible parts. When servicing use only identical replacement parts.



This symbol indicates "dangerous voltage" inside the product that presents a risk of electric shock or personal injury.



This symbol indicates important instructions accompanying the product.

The apparatus shall not be exposed to dripping or splashing and that no objects filled with liquids, such as vases, shall be placed on the apparatus.

Refer to the identification/rating label located on the back panel of your product for its proper operating voltage.

FCC Regulations state that unauthorized changes or modifications to this equipment may void the user's authority to operate it.

Caution: Using video games or any external accessory with fixed images for extended periods of time can cause them to be permanently imprinted on the picture tube (or projection TV picture tubes). ALSO, some network/program logos, phone numbers, black borders (sides, top and bottom), etc. may cause similar damage. This damage is not covered by your warranty.

Cable TV Installer: This reminder is provided to call your attention to Article 820-40 of the National Electrical Code (Section 54 of the Canadian Electrical Code, Part 1) which provides guidelines for proper grounding and, in particular, specifies that the cable ground shall be connected to the grounding system of the building as close to the point of cable entry as practical.

Warning: Do not use the Freeze feature for an extended period of time. This can cause the image to be permanently imprinted on the picture tube. Such damage is not covered by your warranty. Press any button to unfreeze the picture at any time.

Product Registration

Please fill out the product registration card (packed separately) and return it immediately, or register on-line at rca.com. Returning the card allows us to contact you if needed.

Product Information

Keep your sales receipt to obtain warranty parts and service and for proof of purchase. Attach it here and record the serial and model numbers in case you need them. These numbers are located on the product.

Model No. _____

Serial No. _____

Purchase Date: _____

Dealer/Address/Phone: _____

IMPORTANT SAFETY INSTRUCTIONS

1. Read these instructions.
2. Keep these instructions.
3. Heed all warnings.
4. Follow all instructions.
5. Do not use this apparatus near water.
6. Clean only with dry cloth.
7. Do not block any ventilation openings. Install in accordance with the manufacturer's instructions.
8. Do not install near any heat sources such as radiators, heat registers, stoves, or other apparatus (including amplifiers) that produce heat.
9. Do not defeat the safety purpose of the polarized or grounding-type plug. A polarized plug has two blades with one wider than the other. A grounding type plug has two blades and a third grounding prong. The wide blade or the third prong is provided for your safety. If the provided plug does not fit into your outlet, consult an electrician for replacement of the obsolete outlet.
10. Protect the power cord from being walked on or pinched particularly at plugs, convenience receptacles, and the point where they exit from the apparatus.
11. Only use attachments/accessories specified by the manufacturer.
12. Use only with the cart, stand, tripod, bracket, or table specified by the manufacturer, or sold with the apparatus. When a cart is used, use caution when moving the cart/apparatus combination to avoid injury from tip-over.
13. Unplug this apparatus during lightning storms or when unused for long periods of time.
14. Refer all servicing to qualified service personnel. Servicing is required when the apparatus has been damaged in any way, such as power-supply cord or plug is damaged, liquid has been spilled or objects have fallen into the apparatus, the apparatus has been exposed to rain or moisture, does not operate normally, or has been dropped.



If an outside antenna is connected to the TV receiver, be sure the antenna system is grounded so as to provide some protection against voltage surges and built up static charges. In the U.S. Section 810-21 of the National Electrical Code and in Canada, Part 1 of the Canadian Electrical Code provides information with respect to proper grounding of the antenna system. See the figure on the right for details.

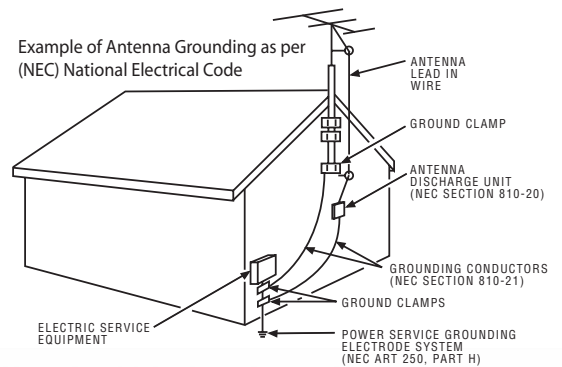

To assure adequate ventilation for this product, maintain a spacing of 4 inches from the top and sides of the TV receiver and 2 inches from the rear of the TV receiver and other surfaces.

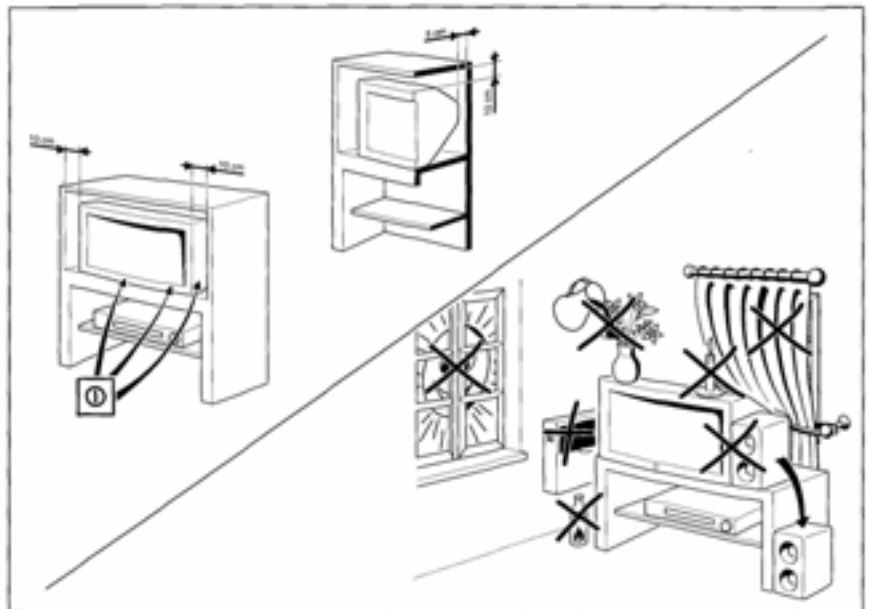

Introduction

Key Features Overview

Your TV is equipped with features that will add to your TV viewing experience. The following information summarizes a few of these features. Chapter 4 provides more information about the rest of the TV's features and how to use them.

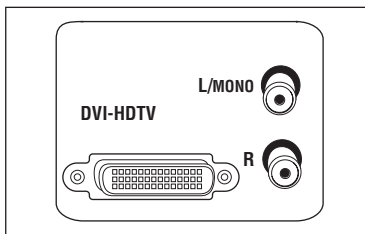

DVI-HDTV Input

Lets you connect an HD receiver with a DVI output.

- **DVI (Digital Visual Interface)** Provides an uncompressed, digital video interface developed for high-bandwidth digital connection. It supports the overlay of high-resolution graphics needed by some electronic program guide navigation and other interactive services. DVI, when combined with HDCP (High bandwidth Digital Content Protection) technology, creates a protected digital connection. The signal speed of the DVI connection is 1080i for HDTV at a rate of 1.78 Gigabits per second.

Dolby* Virtual

Available only for stereo signals. Creates a virtualized surround sound experience from two speakers using the Dolby Pro Logic decoding. It provides the sensation of being surrounded by additional speakers.

PIP (Picture-In-Picture) and POP (Picture-Outside-Picture)

Description: PIP lets you watch two channels at one time – one channel on the main screen and the other in a smaller window. POP also lets you watch two channels at one time- one channel on the left side of the screen (the main picture) and the other on the right.

Requirements: Press the PIP button to bring up the PIP window. Press again to bring up POP. Chapter 4 has detailed instructions on how to use the PIP and POP features.



PIP example



POP example

MP3 Audio Disc Playback

Description: Your DVD player can play back compatible MP3 audio files recorded on CD-R discs.

Requirements: The discs must be recorded on compatible equipment (Chapter 3 has details) and the DVD player must be on.

The On-Screen DVD Information Display

Description: The Info Display is a menu bar that you can bring up to access certain features while discs are playing. Icons represent the different features supported by your TV/DVD when in DVD mode. By selecting different Info Display icons, you can access features including Repeat, Audio, Subtitles, Bookmarks and Camera Angle.

Requirements: Put your TV/DVD in DVD mode and insert a disc into the disc tray. Wait for the disc to play, then press INFO to view the Info Display menu.

V-Chip: Parental Controls

Description: You can block programs and movies by content, age-based ratings, and/or movie ratings.

Requirements:

- Set up the *Parental Control* menu in the TV's main menu (Chapter 4 has details).
- The broadcasters must use the rating system when they send the program to your TV in order for your TV to block the program.
- Parental controls must be locked for these settings to take affect.



* Dolby is a trademark of Dolby Laboratories

IMPORTANT SAFETY INSTRUCTIONS	1	How to Use the Remote After You've Programmed It	16
Introduction		Remote Control Codes	16
Key Features Overview	2	Chapter 3: Playing DVDs	
DVI-HDTV Input	2	Regional Coding	18
Dolby* Virtual	2	Using Different Menus	18
PIP (Picture-In-Picture) and POP (Picture-Outside-Picture)	2	Loading and Playing Discs	18
MP3 Audio Disc Playback	2	To Load and Play a Disc	18
The On-Screen DVD Information Display	2	Using a Disc Menu	18
V-Chip: Parental Controls	2	Using the On-Screen Info Display	18
Chapter 1: Connections & Setup		Time Display	19
Things to Consider Before You Connect	5	Selecting a Title	19
Protect Against Power Surges	5	Selecting a Chapter	19
Protect Components from Overheating	5	Selecting Subtitles	19
Position Cables Properly to Avoid Audio Interference	5	Changing the Audio Language	20
Important Stand and Base Safety Information	5	Using the Repeat Feature	20
Use Indirect Light	5	Using Bookmarks	21
Cables Needed to Connect Components to Your TV	5	Changing the Camera Angle	21
Choose Your Connection	6	Chapter 4: Using the TV's Features	
TV/DVD + HD Receiver + VCR	7	Channel Banner	22
TV/DVD + Satellite Receiver + VCR	8	Why You Should Use the Autotuning Feature	22
TV/DVD + VCR	9	How to Set Up the Autotuning Feature	22
TV/DVD+ A/V Receiver or Speakers	10	Parental Controls and V-Chip	23
Explanation of Jacks	11	How V-Chip Works	23
The Front of Your TV/DVD	12	V-Chip TV Rating	23
Front Inputs	12	Blocking Specific Content Themes	24
Front Panel Buttons	12	Viewing Specific Content Themes	25
Put batteries in the remote	12	V-Chip Movie Rating Limit	25
Turn on the TV/DVD	12	V-Chip Unrated Program Block	25
Complete the Initial Setup	12	Lock/Unlock Parental Controls	25
Set the Menu Language	13	Front Panel Block	25
Complete Auto Channel Search	13	PIP (Picture-in-Picture) and POP (Picture-outside-Picture) Operation	26
Changing Lists and Labels	13	PIP and POP Buttons	26
Auto Convergence	13	Chapter 5: Using the DVD Menu	
Chapter 2: Using the Remote Control		The DVD's Menu System	27
The Buttons on the Remote Control	14	The Play/Resume Play Option	27
Using the INPUT Button	15	The Play Mode Menu	27
Programming the Remote to Operate Other Components	15	Selecting a Play Mode	27
Find Out If You Need to Program the Remote	15	How to Create a Program	27
Programming the Remote	15	Editing a Program	28
		Deleting Chapters	28
		AutoPlay	28
		Dub Assist	28
		IntroScan	28

Table of Contents

The Lock Menu	28	Chapter 8: Other Information	
Locking Your DVD	29	Troubleshooting	40
Unlocking Your DVD	29	Care and Cleaning	43
Changing Your Password	29	Handling Cautions	43
Setting the Ratings Limits	29	Formation of Condensation	43
Unrated Titles	30	Limited Warranty	44
System Test	30	Accessories	45
The Display Menu	30		
TV Image	30		
On-Screen Displays	30		
The Sound Menu	31		
Digital Output	31		
Sound Logic	31		
The Languages Menu	31		
Changing the Player Menus, Disc Menus, Audio or Subtitles Language Preferences ...	31		
Glossary	32		
Code List	32		
Chapter 6: Using the TV's Menu System			
Sound Menu	33		
Picture Menu	33		
Channel Guide Menu	34		
Time Menu	34		
Parental Control Menu	34		
PIP Menu	34		
Setup Menu	35		
Chapter 7: Information Displays			
Using the Info Display	36		
Audio CD Info Display	36		
MP3 Info Display	36		
Video CD Info Display	36		
Using the Time Display	36		
Selecting a Specific Track	36		
Selecting a Specific Index	37		
Selecting a Play Mode	37		
Using the Program Play Feature	37		
Editing a Playlist	38		
Using the Repeat Feature	38		
A•B Repeat	38		
Changing the Audio Channel Output	38		
Using IntroScan	39		
Using Bookmarks	39		
Dub Assist	39		

Chapter 1: Connections & Setup

Things to Consider Before You Connect

Protect Against Power Surges

- Connect all components before you plug any of their power cords into the wall outlet.
- Turn off the TV and/or component before you connect or disconnect any cables.
- Make sure all antennas and cables are properly grounded. Refer to the Important Safety Instructions on page 1.

Protect Components from Overheating

- Don't block ventilation holes on any of the components. Arrange the components so that air can circulate freely.
- Don't stack components.
- When you place components in a stand, make sure you allow adequate ventilation.
- If you connect an audio receiver or amplifier, place it on the top shelf so the heated air from it won't flow around other components.

Position Cables Properly to Avoid Audio Interference

- Insert each cable firmly into the designated jack.
- If you place components above the TV, route all cables down the side of the back of the TV instead of straight down the middle of the TV.
- If your antenna uses 300-ohm twin lead cables, do not coil the cables. Also, keep the twin lead cables away from audio/video cables.

Important Stand and Base Safety Information

Choose the location for your TV carefully. Place the TV on a stand or base that is of adequate size and strength to prevent the TV from being accidentally tipped over, pushed off, or pulled off. This could cause personal injury and/or damage the TV. Refer to the Important Safety Instructions on page 1.

Use Indirect Light

Don't place the TV where sunlight or room lighting will be directed toward the screen. Use soft or indirect lighting.

Cables Needed to Connect Components to Your TV

The pictures below show the cables needed for the connections represented in this book.

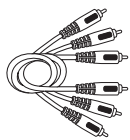

Audio/Video cables

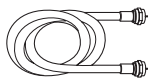

Coaxial cable

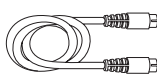

S-Video cable

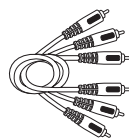









Component Video (Y•Pb•Pr) cables

Connections & Setup

Choose Your Connection

There are several ways to connect your TV/DVD. Please use the following chart to determine which connection is best for you. Proceed to the appropriate page and connect your TV/DVD.

Note: If you prefer, we can provide you with the name of an Authorized Service Representative who will visit your home for a fee to install your electronic entertainment system and to instruct you in its operation. For details about this service, call 1-888-206-3359 or visit rascenium.com.

Components	Cables Needed	Connection Title	Go to...
  	Coaxial Audio/video Component video	TV/DVD + HD Receiver + VCR	page 7
  	Coaxial Audio/video S-Video	TV/DVD + Satellite Receiver + VCR	page 8
 	Coaxial Audio/video Component video	TV/DVD + VCR	page 9

For general information on connecting an A/V receiver or speakers to your TV/DVD, go to page 10.

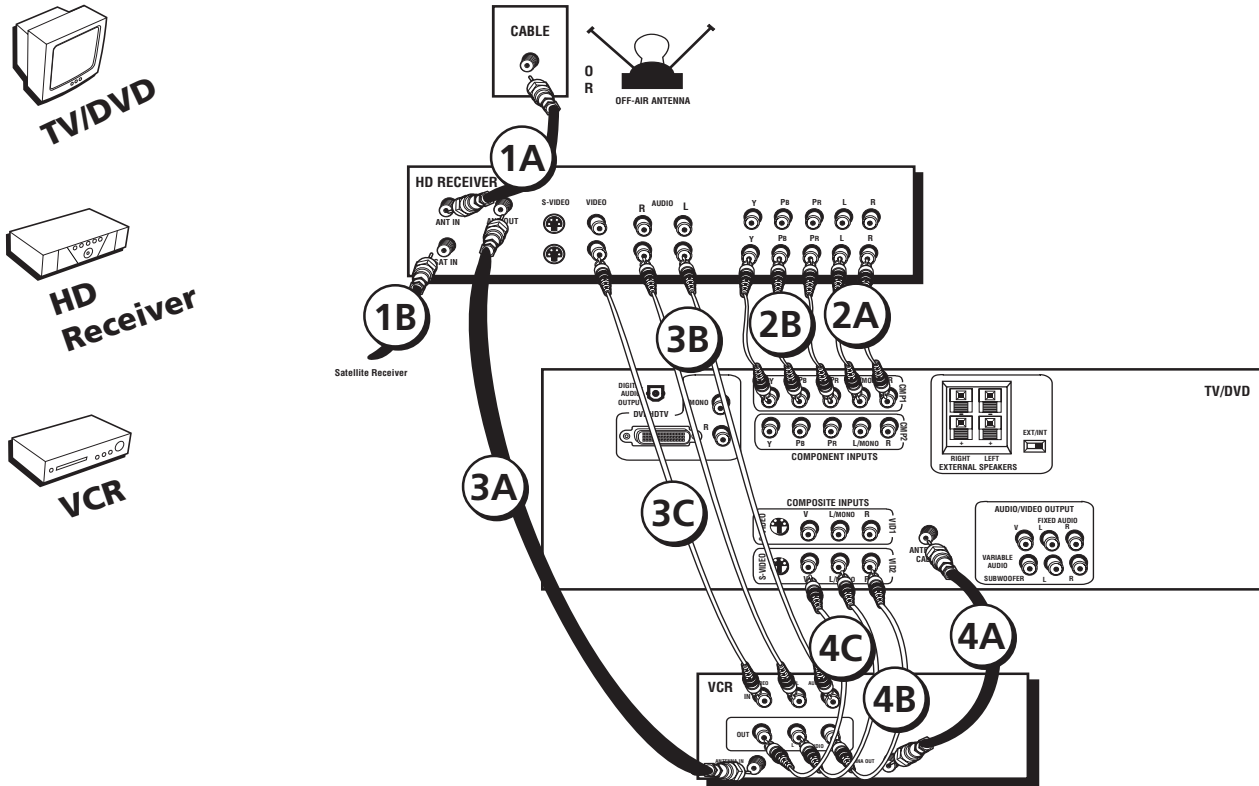

TV/DVD + HD Receiver + VCR

1. Make sure cable or antenna and/or satellite is connected to your VCR.
 - A. Connect the coaxial cable from your cable outlet or antenna to the antenna input on the HD Receiver.
 - B. Connect the satellite dish antenna to the satellite input on the HD Receiver.
2. Connect your HD Receiver to your TV/DVD.
 - A. Connect the audio (white and red) cables to the CMP1 L/MONO and R audio jacks on the back of the TV/DVD and to the Audio Output jacks on the HD Receiver.
 - B. Connect three video grade cables to the CMP1 Y, P_B, P_R jacks on the back of the TV/DVD and to the Y, P_B, P_R jacks on the HD Receiver.

Notes: The Y, P_B, P_R jacks are sending the digital cable signal to the TV/DVD.
If your HD Receiver has a DVI output, connect the HD Receiver to your TV/DVD using a DVI cable. Make sure to connect the left and right audio cables to the DVI L/MONO and R jacks on the TV/DVD.
3. Connect your HD Receiver to your VCR.
 - A. Connect a coaxial cable to the HD Receiver's antenna output and to VCR's antenna input.
 - B. Connect the audio (white and red) cables to the Audio Output jacks on the HD Receiver and to the Audio Input jacks on the VCR.
 - C. Connect the video cable to the Video Output jack on the HD Receiver and to the Video Input jack on the VCR.
4. Connect your VCR to your TV/DVD.
 - A. Connect a coaxial cable to the VCR's antenna output and to the ANTENNA/CABLE Input jack on the TV/DVD.
 - B. Connect the audio (white and red) cables to the VID2 L/MONO and R audio jacks on the back of the TV/DVD and to the Audio Output jacks on the VCR.
 - C. Connect the video cable to the VID2 V (video) jack on the back of the TV/DVD and to the Video Output jack on the VCR.

Go to page 13

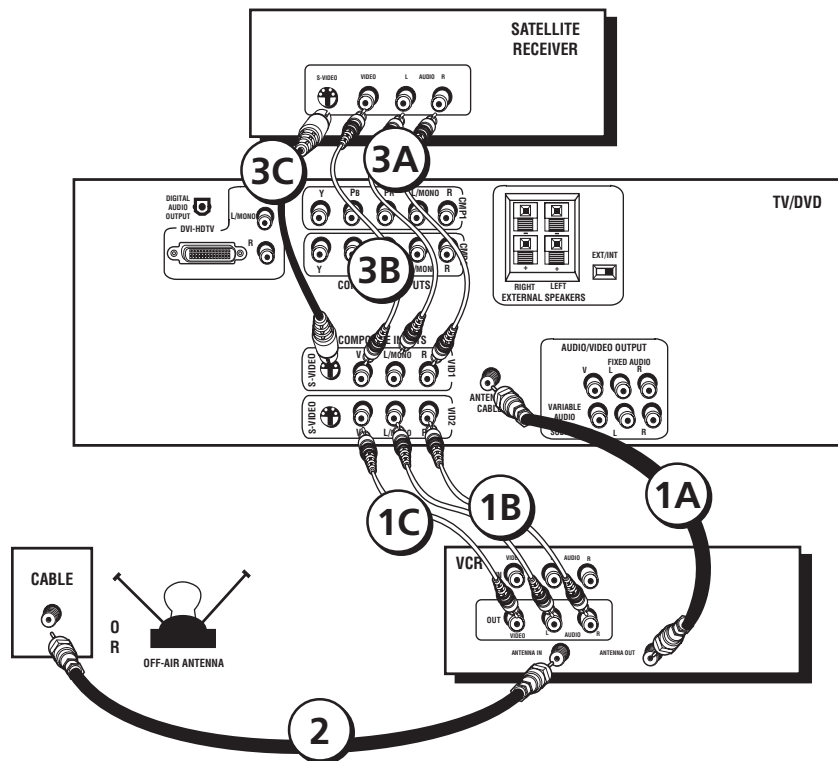
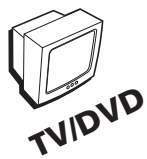

TV/DVD + Satellite Receiver + VCR

1. Connect your VCR to your TV/DVD.
 - A. Connect a coaxial cable to the VCR's antenna output and to the ANTENNA/CABLE Input jack on the TV/DVD.
 - B. Connect the audio (white and red) cables to the VID2 L/MONO and R Audio jacks on the back of the TV/DVD and to the Audio Output jacks on the VCR.
 - C. Connect the video cable to the VID2 V (Video) jack on the back of the TV/DVD and to the Video Output jack on the VCR.
2. Make sure cable or antenna is connected to your VCR.

Connect the coaxial cable from your cable outlet or antenna to the antenna input on the VCR.
3. Connect your Satellite Receiver to your TV/DVD.
 - A. Connect the audio (white and red) cables to the VID1 L/MONO and R Audio jacks on the back of the TV/DVD and to the Audio Output jacks on the Satellite Receiver.
 - B. Connect the video cable to the VID1 V (Video) jack on the back of the TV/DVD and to the Video Output jack on the Satellite Receiver.
 - C. If your Satellite Receiver has an S-Video jack, connect an S-Video cable (instead of the video cable in step B) to the S-VIDEO jack on the TV/DVD and to the S-VIDEO jack on the satellite receiver.

Go to page 13

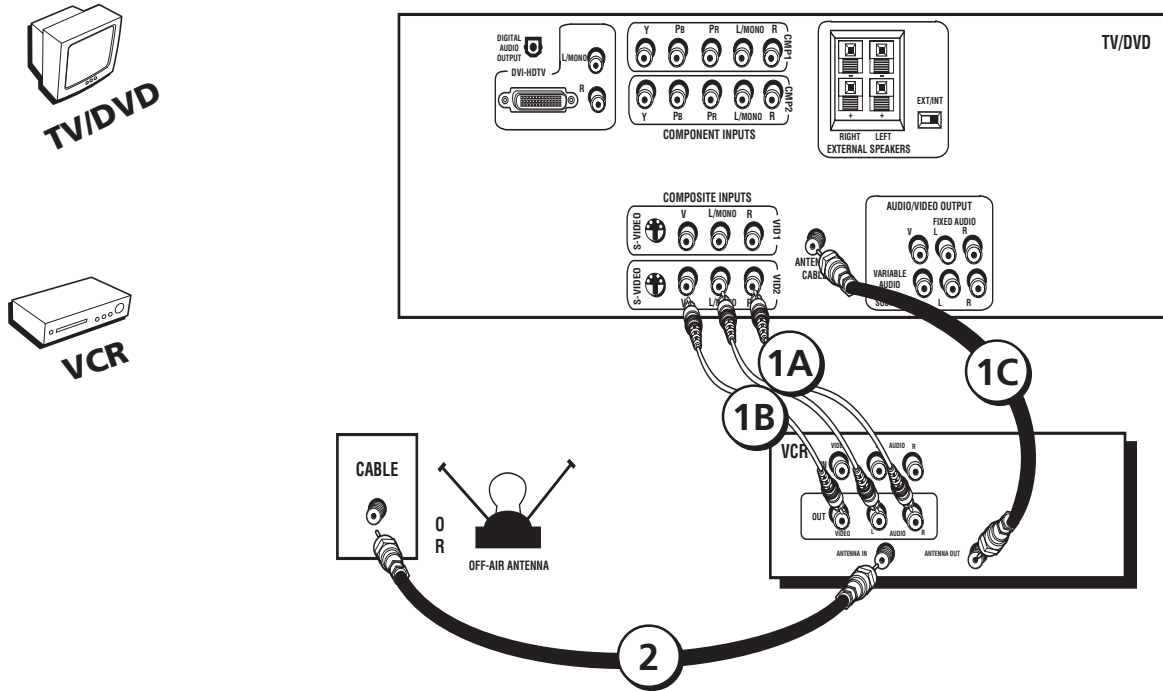

TV/DVD + VCR

1. Connect your VCR to your TV/DVD.
 - A. Connect a coaxial cable to the VCR's antenna output and to the ANTENNA/CABLE Input jack on the TV/DVD.
 - B. Connect the audio (white and red) cables to the VID2 L/MONO and R Audio jacks on the back of the TV/DVD and to the Audio Output jacks on the VCR.
 - C. Connect the video cable to the VID2 V (Video) jack on the back of the TV/DVD and to the Video Output jack on the VCR.
2. Make sure cable or antenna is connected to your VCR.
Connect the coaxial cable from your cable outlet or antenna to the antenna input on the VCR.

Go to page 13

Connections & Setup

TV/DVD+ A/V Receiver or Speakers

These are two different ways your TV/DVD uses a component to hear audio.

1. Connect audio cables to either the FIXED or VARIABLE AUDIO L and R OUTPUT jacks and to the Audio Inputs on the A/V receiver.
 - FIXED provides fixed-level audio output from the TV/DVD. This audio output is ideal for connecting to an A/V receiver that has its own volume control.
 - VARIABLE provides variable-level audio output. Volume levels can be controlled by the volume controls on the TV/DVD and TV remote control.

-OR-

2. Use speaker wire to connect the TV/DVD to external speakers.
 - The EXT/INT switch beside the jacks let you turn the TV/DVD's internal speakers on or off. If you connect external speakers, slide the switch to EXT so the audio is sent to the external speakers only. Choosing INT sends the audio to the TV/DVD's speakers only.

Note: The external speaker rating is 8 ohms with 15 watts power handling capabilities.

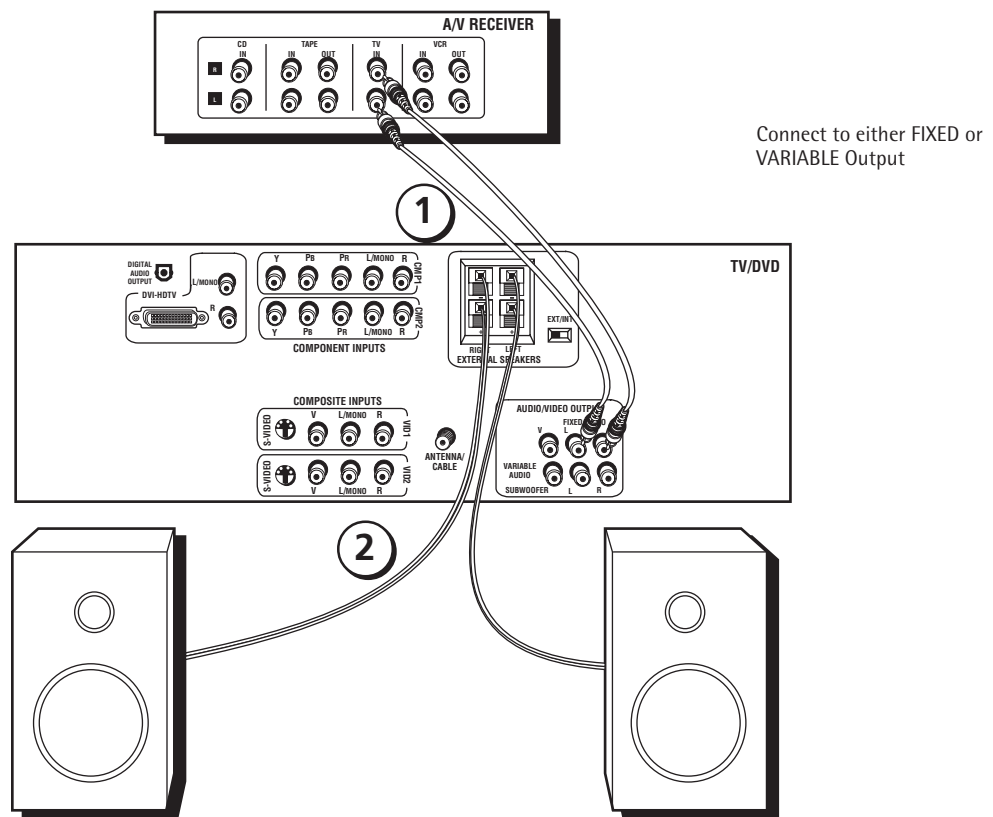

Explanation of Jacks

This section describes the jacks you can use to make connections. There are several ways to connect components to your TV/DVD.

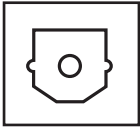

DIGITAL AUDIO OUTPUT Lets you connect a Dolby Digital receiver to your TV/DVD, if your receiver has an optical input. Use an optical cable (or SPDIF cable) to connect your TV/DVD to the receiver for theatre-quality sound. Go to page 30 for more information on digital audio.

Note: This TV/DVD's OPTICAL DIGITAL OUT jack fully complies with the international standard governing this type of jack (IEC958), and is designed for connection to a Dolby Digital (AC-3® or PCM) receiver or Dolby Digital (AC-3 or PCM) decoder. Older equipment, some of which is not fully compliant with IEC958, may not be compatible with the Dolby Digital bitstream. Such a connection using anything other than Dolby Digital AC-3 or PCM receiver or decoder could create a high noise level, causing damage to headphones or speakers.

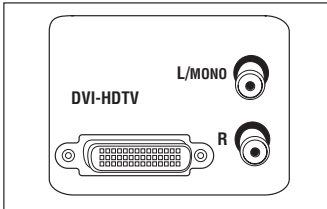

DVI-HDTV Input Lets you connect an HD receiver with a DVI output.

- **DVI (Digital Visual Interface)** Provides an uncompressed, digital video interface developed for high-bandwidth digital connection. It supports the overlay of high-resolution graphics needed by some electronic program guide navigation and other interactive services. DVI, when combined with HDCP (High bandwidth Digital Content Protection) technology, creates a protected digital connection. The signal speed of the DVI connection is 1080i for HDTV at a rate of 1.78 Gigabits per second.
- **L/MONO (Audio)** Provides left audio connection when using the DVI jack. The left audio connector is usually white.
- **R (Audio)** Provides right audio connection when using the DVI jack. The right audio connector is usually red.

Note: Remember to connect the left and right audio cables because the DVI cable carries only the picture signal, not the sound.

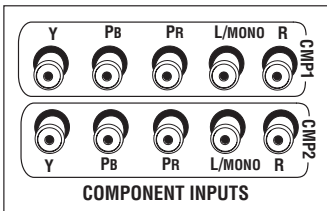

COMPONENT INPUTS Lets you connect a component video source, such as a DVD player.

- **CMP1 Y, P_B, P_R (Component Video)** Provides optimum picture quality because the video is separated into three signals. Use three video-grade cables for the connection. When using CMP1 Y, P_B, P_R, make sure to connect left and right audio cables to the CMP1 L/MONO and R Audio Input jacks.
- **CMP1 L/MONO (Audio)** Provides left audio connection. The left audio connector is usually white.
- **CMP1 R (Audio)** Provides right audio connection. The right audio connector is usually red.
- **CMP2 Y, P_B, P_R, and L/MONO and R Audio** Allows you to connect a second component video source. Their description is the same as CMP1 above. When using CMP2 Y, P_B, P_R, make sure you connect the left and right audio cables to the CMP2 Audio jacks.

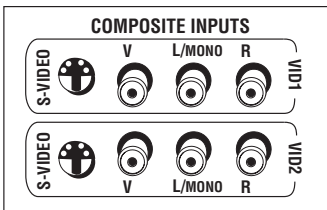

COMPOSITE INPUTS Lets you connect another component such as a VCR, DVD player, or laserdisc player. Its AUDIO jacks are the same as described for CMP1 above.

- **VID1 S-VIDEO** Provides better picture quality than the video jacks (VID1 and 2 Video) because the color part of the signal is separated from the black and white part of the picture. When using VID1 S-VIDEO, make sure to connect left and right audio cables to the VID1 L/MONO and R Audio Input jacks.
- **VID1 V (Video)** Provides composite video connection. The video connector is usually yellow.
- **VID2 S-VIDEO, V and L/MONO and R Audio** Allows you to connect a component such as a VCR, DVD player, or laserdisc player. Their description is the same as VID1 above.

Note: Do not connect an S-Video and Video cable at the same time in either VID1 or VID2 jacks.

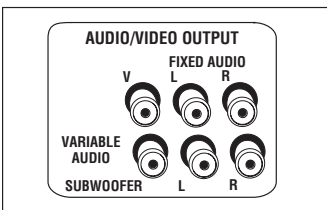

AUDIO/VIDEO OUTPUTS Lets you connect an amplifier or audio receiver for improved sound quality or an external video monitor.

- **FIXED AUDIO L/R** Provides fixed-level audio output from the TV/DVD. This audio output is ideal for connecting to an A/V receiver when you want to control the volume through the A/V receiver.
- **VARIABLE AUDIO** Provides variable-level audio output. Volume levels are controlled by the volume controls on the TV/DVD and remote control.
- **SUBWOOFER** Provides lower bass audio frequencies out from the TV/DVD and to a subwoofer.

Note: If you've connected a subwoofer, make sure you set the External Subwoofer option in the Sound menu. Go to page 33 for instructions.

EXTERNAL SPEAKERS

- **Right and Left Speaker Terminals** Let you connect external left and right speakers to the TV/DVD to receive left and right sound.
- **EXT/INT (switch)** Lets you turn the TV/DVD's internal speakers on or off. EXT sends audio to external speakers only. INT sends audio to the TV/DVD's internal speakers only.

ANTENNA/CABLE Lets you connect a coaxial cable to receive the signal from the antenna, cable, cable box, or if using the examples on pages 7-9, a VCR.

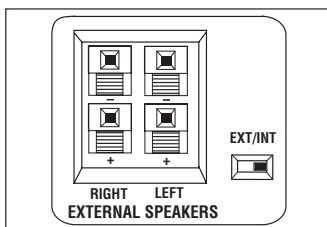

The Front of Your TV/DVD

Front Inputs

The TV/DVD has front inputs for convenience: one set of audio/video inputs, an S-Video and a headphone jack. Locate the jacks either on the front of the TV/DVD or on one of the sides. You can access the component you connected to the front of the TV/DVD by pressing the INPUT button on your remote until FRNT appears on the screen. The jacks are ideal for using a video game console or a camcorder.

Note: When connecting a device that uses a monaural cable, such as some camcorders, use the Left (mono) input jack to get sound from both speakers.

PHONES Allows you to connect headphones to listen to the sound coming from the TV/DVD. To adjust volume control of the headphones, press the VOL > or VOL < button (the volume display appears). Press the arrow up or down button (the headphone volume display appears), then press the right or left arrow button to adjust the headphone volume.

L/MONO and R AUDIO IN Receives audio from another component such as a VCR, camcorder or video game console.

VIDEO IN Receives video from another component such as a VCR, camcorder or video game console.

S-VIDEO IN Allows you to connect an S-Video cable from another component. Make sure you also connect audio cables from the component to the TV/DVD.

Front Panel Buttons

If you cannot locate your remote, you can use the front panel buttons of your TV/DVD to operate many of the TV/DVD's features.

OPEN/CLOSE Press to open and close disc tray.

STOP Stops disc play.

PLAY Begins disc play.

MENU/OK Brings up the TV Main menu. When in the menu system, selects highlighted items.

CH v Scans down through the current channel list. In the TV menu system, acts like down arrow button on the remote control and adjusts menu controls.

CH ^ Scans up through the channel list. In the TV menu system, acts like up arrow button on the remote control and adjusts menu controls.

VOL < Decreases the volume. In the TV menu system, acts like left arrow button on the remote control and adjusts menu controls.

VOL > Increases the volume. In the TV menu system, acts like right arrow button on the remote control and adjusts menu controls.

POWER Turns the TV/DVD on and off.

Put batteries in the remote

- Remove the battery compartment cover from the back of the remote by pushing down on and sliding off the cover.
- Insert 2 "AA" fresh batteries. Make sure the polarities (+ and -) are aligned correctly.
- Replace the cover.

Turn on the TV/DVD

Press TV on the remote, or press POWER on the TV/DVD's front panel.

Note: Pressing the TV button not only turns on the TV, but puts the remote into TV mode. "TV mode" means that the buttons on the remote control operate the TV's functions.

Tip

To access the setup menus manually, press MENU and choose SETUP.

Complete the Initial Setup

The menu system in your TV allows the TV's features to work properly. The first time you turn on your TV/DVD, the setup screens appear.



Set the Menu Language

The first part of the setup allows you to select your preferred language for the menu system.

1. Highlight your preferred language for the menu system using the arrow buttons.
2. Press OK to select that language (the Channel Setup screen appears with *Auto channel search* highlighted).

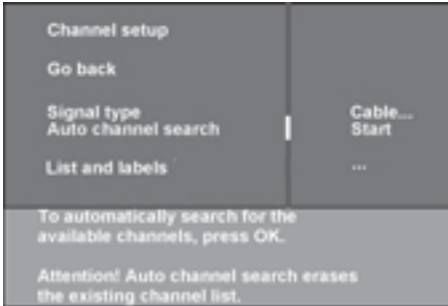

Complete Auto Channel Search

This part of the setup allows the TV to search for all channels viewable through your antenna or cable TV system. This is sometimes called *auto programming*. Press OK to begin auto channel search. When the channel search is complete, press OK to access the *List & Labels* screen.



Changing Lists and Labels

The List & Labels part of the setup lets you edit your channel list and choose or create a personal six-character label for each channel.

Note: Changing List and Labels can be time consuming. You can change these at a later time by accessing the Setup menu.

1. Press the left or right arrow to scroll through the available channels and choose the channel you want to edit.
2. Press the down arrow to highlight the *In channel list* option. Press the left or right arrow button to add (the box is checked) or remove (the box is unchecked) the channel from the list.
3. Press the down arrow to highlight the *Channel label* option. Press the left or right arrow button to scroll through the available list of 25 most common labels. The last option in the list allows you to create your own six-character label for the channel (the first letter of the label is highlighted).
4. Press the 1 or 2 number button to change the first letter of the label.
5. Press the right arrow to highlight the second letter, then press the 1 or 2 number button to change the second letter, etc...
6. When you are finished creating your label, select *Go back* (the *Auto Convergence* menu appears).

Auto Convergence

Your TV/DVD's picture tubes might have been disturbed during delivery or after you moved the TV/DVD, causing the color in your TV/DVD to be out of alignment. The colors adjust by starting auto convergence.

1. Press OK to begin auto convergence.
2. When the auto convergence is complete, the *Red center convergence* menu appears. The cross in the middle of the screen should be yellow. If it is not, use the arrow buttons to move the red cross to overlap the green cross. Press OK when adjustments are complete.
3. The *Blue center convergence* menu appears with a cyan cross in the middle of the screen. If it is not, use the arrow buttons to move the blue cross to overlap the green cross. Press OK (the TV tunes to the last available channel in the channel list).

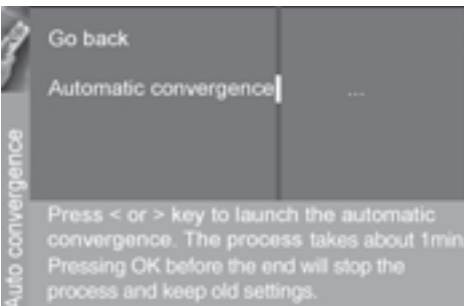

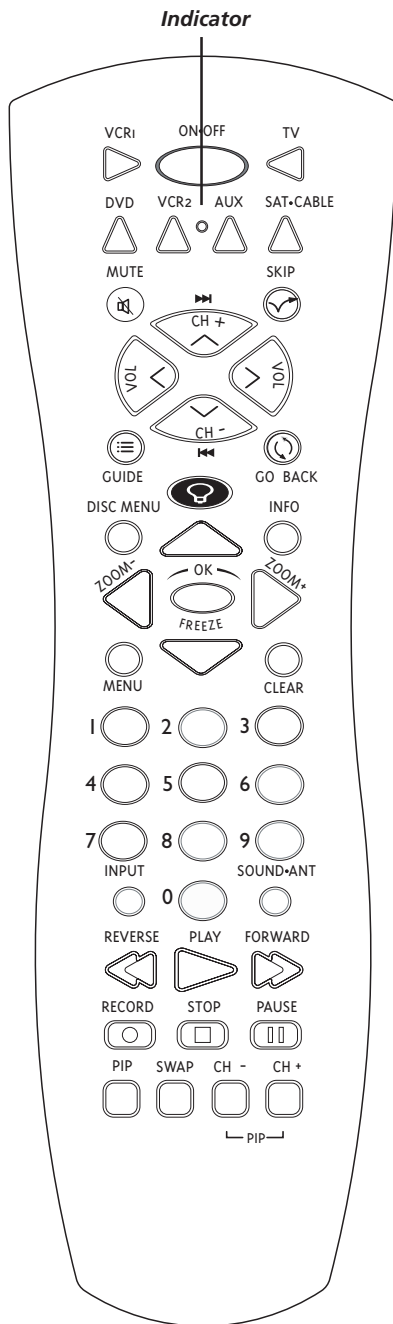

Note: The VCR1, DVD, VCR2, and SAT•CABLE buttons also turn on most RCA, GE, and Proscan products.

Tip

To turn off all the RCA, GE, and Proscan components that are connected to the TV, press ON•OFF twice within two seconds.

This feature only works with most RCA, GE, and Proscan products.

The Buttons on the Remote Control

(0-9) Number Buttons Enter channel numbers and time settings directly through the remote control.

To enter a one-digit channel, enter a zero first. To enter a two-digit channel, press the two digits. To enter a three-digit channel, press and hold the "1" button until "1" and two dashes (- -) appear, then add the second two digits. Example: to tune to channel 123, press and hold 1 until "1- -" appears, release the 1 button and then press 2 and 3.

Arrows Used to point to different items in the TV or DVD menu and to adjust the menu controls. Moves the PIP window when no menus are on the screen. Also switches the two POP windows when no menus are on the screen. For Zoom use, go to next page.

AUX Puts the remote in AUX mode. Can also be programmed to operate most brands of an additional remote-controllable component.

Backlight Lights up some of the buttons in the dark.

CH + or CH - In TV mode, scans up or down through the current channel list. Press once to change the channel up or down; press and hold to continue changing channels. In DVD mode while a disc is playing, CH+ advances to the next chapter; CH- goes to the preceding chapter.

CH+ or CH- PIP When using PIP or POP, changes the channel in the picture window.

CLEAR Removes any menu or display from the screen and returns you to normal viewing.

DISC MENU In DVD mode while a disc is playing, brings up the DVD Disc menu.

DVD Turns on the DVD and puts the remote in DVD mode. Also displays current DVD status.

FORWARD In DVD mode, advances the disc forward.

FREEZE When watching TV, freezes the picture until you press another button to resume normal TV viewing.

Note: Do not use the Freeze feature for an extended period of time. This can cause the image to be permanently imprinted on the picture tube. Such damage is not covered by your warranty. Press any button to unfreeze the picture at any time.

GO BACK In TV mode, returns you to the previous channel. In DVD mode, returns to the previous screen.

GUIDE In TV mode, brings up the Channel Guide menu. In DVD mode, brings up DVD guide, if available.

INDICATOR Indicates the programming mode when programming the remote to control components.

INFO In TV mode, brings up TV status display; press again to clear the screen. In DVD mode, brings up the Info Display.

INPUT Press to toggle through the available input sources (VID1, VID2, FRNT, CMP1, CMP2 and DVI). Press the CH+ or CH- button to resume TV viewing).

MENU In TV mode, brings up the TV Main menu. In DVD mode, brings up a reduced TV Menu.

MUTE Reduces the TV's volume to its minimum level. Press again to restore the volume.

OK/FREEZE When in the menu system, selects highlighted items. When watching TV, freezes the picture until you press another button to resume normal TV viewing.

ON•OFF When in TV mode, turns the TV on and off. If in another device mode (VCR, DVD, SAT•CABLE, etc.) and programmed, will turn the device on and off.

PAUSE In DVD mode, pauses the disc.

PIP Press once to bring up the small picture-in-picture window. Press again to bring up the picture-outside-picture (POP) windows. Press to remove POP. (See Chapter 4 for more information about using PIP.)

PLAY In DVD mode, plays the disc.

RECORD If your TV/DVD is connected to a VCR, records TV programs .

REVERSE In DVD mode, goes backward on a disc.

SAT•CABLE Puts the remote in SAT•CABLE mode and, if Autotuning is enabled, will turn on the TV and tune to the correct input channel.

SKIP Press once before changing channels and the TV will wait 30 seconds before returning you to the original channel. Press repeatedly to add more time.

SOUND•ANT In TV mode, displays the Picture and Sound preset settings at the bottom of the TV. In DVD mode while a disc is playing, displays the DVD Info Display with the Audio icon highlighted.

STOP In DVD mode, stops playing the disc. Press and hold for 3 seconds to open the disc tray.

SWAP When using PIP, swaps the main picture with the PIP window. When using POP, swaps the left and right pictures.

TV Turns on the TV and puts the remote in TV mode. Also displays current status.

VCR1 Puts the remote in VCR1 mode and, if Autotuning is enabled, will turn on the TV and tune to the correct input channel.

VCR2 Puts the remote in VCR2 mode and, if Autotuning is enabled, will turn on the TV and tune to the correct input channel.

VOL – or VOL + Decreases or increases the TV's volume.

ZOOM+ or ZOOM- When watching TV, changes the current format of the screen (4x3, Zoom 14/9, Zoom 16/9, Zoom 16/9 \wedge /v, Cinerama, regular mode 16/9). In DVD mode while playing a 4:3 disc, use the Zoom buttons in the reduced TV menu to change the Zoom mode.

Using the INPUT Button

Use the INPUT button to scroll through the available input channels and view components you have connected to the TV.

1. Press TV to place the remote in TV mode. Make sure the component you want to view is turned ON.
2. Press INPUT to tune to an available input channel.
3. To return to the channel you were previously watching on TV, press CH+ or CH- button.

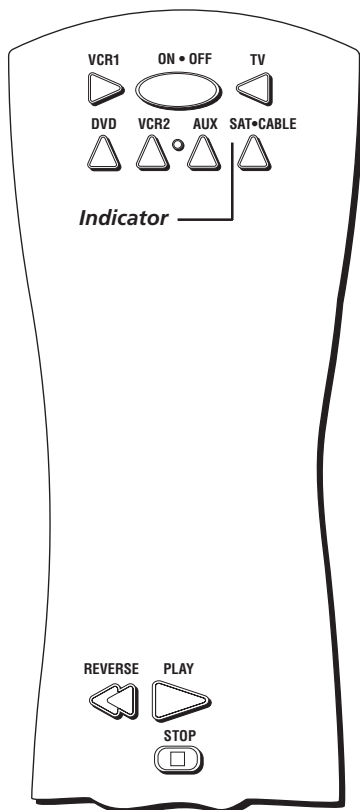

You'll use these buttons when you program the remote.

Important: The remote may not be compatible with all models of all brands of components. It also may not operate all functions of the remote that came with your component.

Tip

To stop the automatic code search without programming any components, press and hold CLEAR until the indicator on the remote turns off.

Programming the Remote to Operate Other Components

The universal remote can be programmed to operate most brands of remote controllable components. The remote is already programmed to operate most RCA, GE, and Proscan components.

Also, the AUX button can be programmed to operate most brands of an additional remote-controllable component.

Note: The TV button can't be programmed on this remote.

Find Out If You Need to Program the Remote

To determine whether the universal remote needs to be programmed for your component, turn the component ON. For example, to program the remote for a VCR, turn on the VCR. Point the remote at the VCR, and press the VCR1 button. Then press ON•OFF or CH + (channel up) or CH – (channel down) to see if the VCR responds to the remote commands. If the component does not respond, the remote needs to be programmed.

Programming the Remote

There are two ways to program the remote control:

- automatic code search
- direct entry

Using Automatic Code Search

The following instructions can be used to program the remote to operate each of your components. If you want to stop the automatic code search without programming any of your components, press CLEAR until the indicator on the remote turns off.

1. Turn on the component you want to operate (VCR, DVD player, etc.)
2. Press and hold the component button you want to program (VCR1, DVD, etc.). While holding the component button, press and hold ON•OFF until the indicator on the remote turns on, then release both buttons.
3. Point the remote at the component. Press and release PLAY, then wait 5 seconds or until the indicator on the remote stops flashing.

At this point the remote is searching for the correct code to program. If, after 5 seconds, the component you want to operate does not turn off, press PLAY again to tell the remote to search the next set of codes.

Continue pressing PLAY until the component turns off or you have searched through all of the codes. There are 20 total sets of codes. If the component does not turn off after pressing PLAY 20 times, then the remote can't be programmed to operate that component.

If the component you want to control *does* turn off:

1. Press and release REVERSE, then wait 2 seconds. Repeat this step until the device turns back ON.
2. To finish, press and hold STOP until the indicator on the remote turns off.

Using the Remote Control

Important

You must continue pressing the component button while you enter the code.

Let's say you have a Zenith VCR. To program the universal remote to operate the VCR, you would:

Press and hold the VCR1 button while you enter the first code listed for Zenith in the VCR Codes column.

Release the VCR1 button. Press ON•OFF to see if the VCR responds. If it doesn't, follow the same steps, but enter the second code for Zenith VCRs instead of the first.

Note

Some of the remote's buttons might operate differently for other components, especially when you're using another component's menu system.

Using Direct Entry

1. Turn on the component to be programmed.
 2. Look up the brand and code number(s) for the component on the code list in this section.
 3. Point the remote at the component.
 4. Press and hold the component button you want to program on the remote.
 5. Enter the 4-digit code from the remote control code list on the following pages. If the indicator flashes, you have either entered an invalid code or the button isn't programmable.
 6. Release the component button, and then press ON•OFF to see if the component responds to the command. If it doesn't, try pressing the component button and then ON•OFF again.
- If you get no response, repeat these steps using the next code listed for your brand, until the component responds to the remote commands.
 - If you try all the codes for your component brand and none work, try the automatic code search method. If automatic code search doesn't find the code, the remote is not compatible with your component.

How to Use the Remote After You've Programmed It

Because this universal remote can control several different components (TV, DVD, VCR, satellite receiver, etc.) it uses operational modes triggered by the component buttons. For example, if you want the remote to control the TV, you would press the TV button to put the remote into TV mode before you could control the TV.

1. Press the appropriate component button (DVD, TV, VCR1, VCR2, SAT•CABLE, AUX) to set the remote to control the component.
2. Press ON•OFF to turn the component ON or OFF.
3. Use the remote buttons that apply to that component.

Notes: The remote may not be compatible with all brands and models of components. It also may not operate all functions of the remote that came with your component.

If you keep pressing buttons and nothing happens, the remote is probably in the wrong mode. You must press the component button that matches the component you want to operate (i.e., if you want to operate the VCR, press VCR1 on the remote control to put the remote in VCR mode.)

Remote Control Codes

VCR Codes

Programmable for VCR1, VCR2, and AUX buttons.

Admiral	2132
Adventura	2026
Aiko	2027
Aiwa	2026
Akai	2003, 2004, 2005, 2007, 2008, 2111, 2112, 2113
American High	2021
Asha	2013
Audio Dynamics	2009, 2010
Audiovox	2014
Bell & Howell	2011
Beaumarck	2013
Broksonic	2012, 2025
Calix	2014
Candle	2013, 2014, 2015, 2016, 2017, 2018, 2019
Canon	2021, 2022, 2114
Capehart	2020, 2110
Carver	2062
CCE	2027, 2061
Citizen	2013, 2014, 2015, 2016, 2017, 2018, 2019, 2027
Colortyme	2009
Colt	2061
Craig	2013, 2014, 2023, 2061
Curtis-Mathes	2000, 2009, 2013, 2016, 2018, 2021, 2022, 2024, 2115, 2131
Cybermex	2013
Daewoo	2015, 2017, 2019, 2025, 2026, 2027, 2028, 2110
Daytron	2110

DBX	2009, 2010
Dimensia	2000, 2131
Dynatech	2026
Electrohome	2014, 2029
Electrohome	2014
Emerson	2012, 2014, 2015, 2021, 2024, 2025, 2026, 2029, 2030, 2031, 2032, 2033, 2034, 2035, 2036, 2037, 2038, 2039, 2040, 2041, 2042, 2044, 2045, 2046, 2047, 2065, 2113, 2116, 2117, 2130
Fisher	2011, 2023, 2048, 2049, 2050, 2051, 2052, 2118
Fuji	2021, 2119
Funai	2026
Garrard	2026
GE	2000, 2001, 2013, 2021, 2022, 2053, 2115, 2120, 2131
Goldstar	2009, 2014, 2018, 2054
Gradiente	2026
Harley Davidson	2026
Harman Kardon	2009
Harwood	2061
Headquarter	2011
Hitachi	2055, 2056, 2057, 2107, 2111, 2120, 2122
Hi-Q	2023
Instant Replay	2021
JCL	2021
JC Penney	2009, 2010, 2011, 2013, 2014, 2021, 2022, 2055, 2056, 2058, 2059, 2060, 2107, 2118
Jensen	2055, 2056, 2111
JVC	2009, 2010, 2011, 2018, 2111, 2123
Kenwood	2009, 2010, 2011, 2016, 2018, 2111, 2123
KLH	2061
Kodak	2014, 2021
Lloyd	2026
Logik	2061

LXI	2014
Magnavox	2021, 2022, 2062, 2063, 2104, 2105, 2108, 2124
Magnin	2013
Marantz	2009, 2010, 2011, 2016, 2018, 2021, 2062, 2064
Marta	2014
Masushita	2021
Mei	2021
Memorex	2011, 2013, 2014, 2021, 2023, 2026, 2104, 2132
MGA	2029, 2065, 2113
MGN Technology	2013
Midland	2053
Minolta	2055, 2056, 2107
Mitsubishi	2029, 2055, 2056, 2065, 2066, 2067, 2068, 2068, 2070, 2071, 2072, 2073, 2074, 2106, 2113, 2123
Montgomery Ward	2075, 2132
Motorola	2021, 2132
MTC	2013, 2126
Multitech	2013, 2016, 2026, 2053, 2061
NEC	2009, 2010, 2011, 2016, 2018, 2064, 2076, 2078, 2079, 2111, 2123
Nikko	2014
Noblex	2013
Olympus	2021
Optimus	2014, 2132
Optonica	2096
Panasonic	2021, 2022, 2109, 2125, 2126, 2127
Pentax	2016, 2055, 2056, 2107, 2120
Pentax Research	2018
Philco	2021, 2022, 2062, 2063
Philips	2021, 2062, 2096, 2124
Pilot	2014
Pioneer	2010, 2055, 2080, 2081, 2123
Portland	2016, 2017, 2019, 2110
Proscan	2000, 2001, 2131

VCR Codes continued

Protec	2061
Pulsar	2104
Quarter	2011
Quartz	2011
Quasar	2021, 2022, 2125
RCA	2000, 2001, 2003, 2013, 2021, 2055, 2056, 2082, 2083, 2084, 2085, 2086, 2087, 2088, 2089, 2090, 2091, 2107, 2115, 2120, 2125, 2131, 2133
Radioshack/Realistic	2011, 2013, 2014, 2021, 2022, 2023, 2026, 2029, 2049, 2050, 2096, 2132
Radix	2014
Randex	2014
Ricoh	2128
Runco	2104
Samsung	2005, 2013, 2015, 2033, 2053, 2112
Sanky	2104, 2132
Sansui	2010, 2092, 2111, 2123
Sanyo	2011, 2013, 2023
Scott	2012, 2015, 2025, 2032, 2038, 2065, 2093, 2116
Sears	2011, 2014, 2021, 2023, 2048, 2049, 2050, 2051, 2055, 2056, 2107, 2118
Sharp	2017, 2029, 2094, 2095, 2096, 2097, 2132
Shintom	2004, 2056, 2061, 2098
Shogun	2013
Signature	2132
Singer	2021, 2061, 2128
Sony	2004, 2098, 2099, 2119
STS	2021, 2107
Sylvania	2021, 2022, 2026, 2062, 2063, 2065, 2124
Symphonic	2026
Tandy	2011
Tashiko	2014
Tatung	2111
TEAC	2026, 2085, 2111
Technics	2021, 2109
Teknika	2014, 2021, 2026, 2100, 2129
TMK	2013, 2024, 2047
Toshiba	2015, 2049, 2051, 2055, 2065, 2093, 2116
Totevision	2013, 2014
Unitech	2013
Vector Research	2009, 2010, 2015, 2016
Victor	2010
Video Concepts	2009, 2010, 2015, 2016, 2113
Videosonic	2013
Wards	2013, 2014, 2015, 2021, 2023, 2026, 2029, 2055, 2056, 2061, 2096, 2101, 2102, 2103, 2107, 2116, 2132
XR-1000	2021, 2026, 2061
Yamaha	2009, 2010, 2011, 2018, 2111
Zenith	2004, 2098, 2104, 2119, 2128

Satellite Receiver Codes

Programmable for SAT•CABLE and AUX buttons.

Alphastar	5079
Chapparral	5056, 5057
Dishnet	5078
Drake	5058, 5059
Echostar	5089
GE	5000, 5001
General Instruments	5060, 5061, 5062
Hitachi	5083, 5084
Hughes	5077, 5090
JVC	5082
Panasonic	5075
Philips	5085
Primestar	5076
Proscan	5000, 5001
RCA	5000, 5001, 5071, 5080, 5081
Realistic	5063
Sony	5072
STS1	5064
STS2	5065
STS3	5066
STS4	5067
Toshiba	5068, 5073
Uniden	5069, 5086

Cable Box Codes

Programmable for SAT•CABLE and AUX buttons.

ABC	5002, 5003, 5004, 5006, 5053
Antronix	5008, 5009
Archer	5008, 5009, 5010
Cabletenna	5008
Cableview	5008
Colour Voice	5012, 5013
Comtronics	5014
Contec	5016
Eastern	5017
GC Electronics	5009
GE	5000, 5001
Gemini	5018, 5019
General Instrument	5003
Hamlin	5020, 5021, 5022, 5028, 5035, 5045
Hitachi	5003
Jerrold	5003, 5018, 5023, 5024, 5046, 5053
Magnavox	5025
Memorex	5026
Movie Time	5027
NEC	5005
NSC	5027
Oak	5016, 5029
Panasonic	5048, 5052
Philips	5011, 5012, 5013, 5015, 5019, 5025, 5030, 5031, 5032
Pioneer	5033, 5034
Proscan	5000, 5001
RCA	5007, 5047, 5049, 5052
Realistic	5009
Regal	5022, 5035
Regency	5017
Rembrandt	5003
Samsung	5034
Scientific Atlanta	5006, 5036, 5037, 5038
Signal	5018
Signature	5003
Sprucer	5052
Standard Components	5039, 5044
Starcom	5018, 5053
Stargate	5018
Starquest	5018
Tocom	5004, 5023
Tusa	5018
TV86	5027
Unika	5008, 5009
United Cable	5053
Universal	5008, 5009, 5010
Viewstar	5025, 5027
Zenith	5050, 5051

DVD codes

Programmable for the AUX button.

Aiwa	3009
GE	3000
Hitachi	3008
JVC	3002, 3010
Konka	3011, 3012
Magnavox	3003
Mitsubishi	3004
Panasonic	3013
Philips	3003, 3019, 3021, 3022
Pioneer	3005
Proscan	3000
RCA	3000, 3001
Sanyo	3014
Sony	3006, 3015, 3016
Toshiba	3007, 3017, 3020
Zenith	3018

Audio Codes

Programmable for the AUX button only.

RCA and Dimensia

AM/FM	4003, 4270
AUX	4004
Phono	4005
Tape	4006
CD	4007, 4190, 4211

Receivers

Aiwa	4261, 4262, 4263, 4264, 4265, 4266, 4267, 4277
Denon	4283
Harman Kardon	4276
JVC	4268
JVL	4276
Kenwood	4269
Onkyo	4278
Optimus	4284
Panasonic	4279, 4280
Pioneer	4275
RCA	4270
Sherwood	4282
Sony	4271, 4272, 4281
Technics	4279, 4280
Wards	4275
Yamaha	4274, 4275

CD Players

ADC	4200, 4201, 4220
Aiwa	4175, 4203
Akai	4205
Denon	4208
Dynatech	4177
Emerson	4178
Fisher	4179, 4212, 4213
GE	4216
Hitachi	4180
JVC	4181, 4221
Kenwood	4183, 4222, 4224
Luxman	4225
Marantz	4185, 4226
Mitsubishi	4229, 4230
MCS	4228
Nakamichi	4232, 4233
NEC	4184
Onkyo	4186, 4234, 4235
Optimus	4237, 4238, 4239
Panasonic	4188
Pioneer	4189, 4240
RCA	4190, 4211
Sanyo	4250
Sears	4207
Sherwood	4243
Sony	4195, 4209, 4244
Teac	4245, 4246, 4247
Technics	4197
Toshiba	4231
Yamaha	4198, 4199, 4248

Chapter 3: Playing DVDs

Regional Coding

Both the TV/DVD unit and the discs are coded by region. These regional codes must match in order for the disc to play. If the codes don't match, the disc won't play. This unit's code is region 1.

Using Different Menus

Each disc is programmed with different features. There are three separate menu paths that you can use to access features:

- **The Disc menu** – The disc menu is part of each disc and is separate from the DVD's menu system. The contents of each disc menu vary according to how the disc was authored and what features are included. The disc menu is turned on and off (while the disc is playing) with the DISC MENU button on the remote.
- **The DVD's Info Display** – The Info Display appears as icons across the top of the screen when a disc is playing. It can only be accessed while you are playing a disc. It's turned on and off with the INFO button on the remote.
- **The DVD's menu system** – The DVD's menu system is accessed only when a disc isn't playing. It appears when the STOP button is pressed.

A feature only works if the disc was programmed with that feature. If a menu item is "grayed out" it means that item isn't available.

Loading and Playing Discs

Your TV/DVD unit plays DVD discs, Video CD discs, Audio CD discs, MP3 discs and CD-R discs. Before you load a disc, make sure that it is compatible with the player. The following discs CANNOT be used with this player:

- Laserdiscs, CD-I, CD-ROM (computer-only discs), CD-RW, DVD-ROM, Discs recorded using other broadcast standards (i.e. PAL or SECAM)



This is an example of a one-sided disc.



This is an example of a 2-sided disc. The title is in the center.

To Load and Play a Disc

To put the TV/DVD in DVD mode and play a disc, press the DVD button on the remote control.

1. Press the OPEN•CLOSE button on the front of the TV/DVD. The disc tray opens.
2. Place a disc gently into the tray with the disc's label facing up (double-sided discs have content on both sides, so you can place either side up).
3. Press the OPEN•CLOSE or PLAY button. The disc tray closes.

The TV/DVD reads the disc's table of contents, and then one of three things happens depending on how the disc was programmed:

- The disc starts playing.
- The disc menu appears on the screen. One of the options will start disc play. Highlight that option and press OK on the remote.
- The DVD's main menu appears on the screen. Highlight the *Play* option and press OK on the remote.

When you stop playing a disc, the unit remembers where you stopped. When you start playing the disc again, the unit picks up where you left off unless the disc is removed, the unit is unplugged, or you pressed the STOP button twice.

Using a Disc Menu

A disc is capable of having an on-screen menu that is separate from the DVD's menu system and on-screen Info Display. The disc menu might only contain a list of the titles and chapters, or it may allow you to change features such as language and playback settings.

The content and operation of disc menus vary from disc to disc.

Using the On-Screen Info Display

The on-screen Info Display contains many playback features. To see the Info Display, press the INFO button on the remote while a disc is playing. The Info Display appears across the top of the screen. Each feature is illustrated with an icon. Use the left/right arrow buttons on the remote to move through the different icons in the Info Display.

When an icon is highlighted, use the up/down arrow buttons on the remote to scroll through the choices displayed in the text box under the icons.

Remember, you can only access the Info Display when you're playing a disc. Also, the Info Display features are only available if the disc was created with that particular feature (i.e., if you select the Subtitle icon, you won't be able to change the subtitle language unless the author of the disc created the disc with subtitles).

The invalid symbol  appears on the screen when you press a button that doesn't have any function. If one of the icons is "grayed out," that Info Display feature isn't available for the disc you're playing. To make the Info Display disappear from the screen, press INFO on the remote.

This product incorporates copyright protection technology that is protected by method claims of certain U.S. patents and other intellectual property rights owned by Macrovision Corporation and other rights owners. Use of this copyright protection technology must be authorized by Macrovision Corporation, and is intended for home use only unless otherwise authorized by Macrovision Corporation. Reverse engineering or disassembly is prohibited.

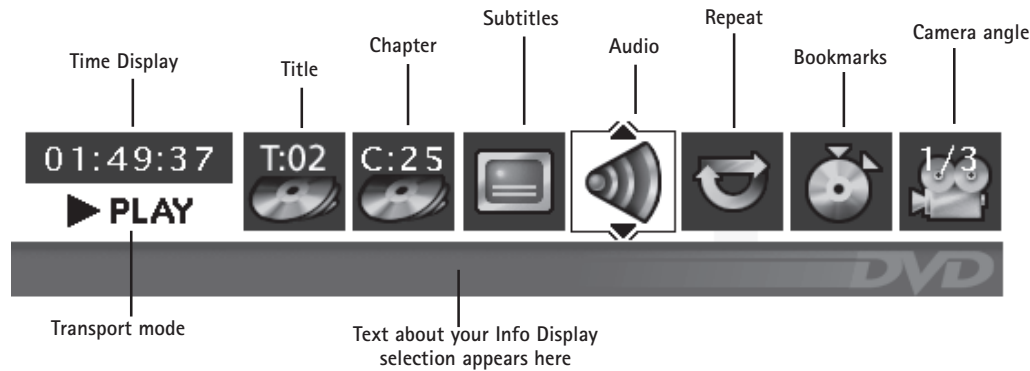

Time Display

This feature displays the audio/video time. For DVD discs, the time displayed refers to the current title time. For Audio CDs, it refers to the current track time.

For DVD video discs, the Time Display also acts as a Time Search feature. This lets you go to a particular scene in a movie by entering the time that scene is played. To use Time Search:

Press INFO on the remote to bring up the Info Display. Highlight the Time Display and enter the elapsed time of the scene you wish to go to. For example, enter 01:12:00 to go to the scene that plays at 1 hour and twelve minutes into the movie.

When you've entered the time, press OK on the remote.

Selecting a Title

Some discs contain more than one title. Each title is divided into chapters. To select a title:

1. While the disc is playing, press INFO on the remote to bring up the Info Display.
2. If the *Title* icon on the Info Display isn't highlighted, use the left/right arrow buttons to highlight it.
3. Use the number button(s) on the remote to enter the title number or press the up/down arrow buttons to go to the next/previous title.
4. Press OK on the remote when the title you want to play appears in the text window.

Note: Some discs only have one title.

Selecting a Chapter

Because DVD discs use digital technology, a title can be divided into individual chapters (similar to tracks on a CD). You can skip to a specific chapter by using the Chapter feature in the Info Display.

1. While a disc is playing, press INFO on the remote to bring up the Info Display.
2. Press the left/right arrow buttons to highlight the *Chapter* icon.
3. Use the number buttons on the remote to enter the number of the chapter you want to play or press the up/down arrow buttons to go to the next/previous title.
4. Press OK on the remote.

Notes: The Chapter feature won't work if the disc isn't formatted with separate chapters.

Press CH + or CH - on the remote to highlight the Chapter icon. Then press CH + to advance to the next chapter or CH - to go to the preceding chapter.



Selecting Subtitles

By default, subtitles are off. To turn subtitles on and change the Subtitle language while you're watching a DVD disc:

1. While the disc is playing, press INFO on the remote.
2. Press the left/right arrow buttons to highlight the *Subtitle* icon.
3. If subtitles are off, press OK to turn them on.
4. Use the up/down arrow buttons to scroll through the subtitle languages that are available on the disc. If subtitles aren't available, the text in the text box will read *Subtitles: Not Available*. If subtitles are available, the language currently showing in the text box is the active selection. The subtitles will be shown in that language.
5. To make the Info Display disappear, press the INFO button on the remote.

Notes: Changing the subtitle language with the Info Display will only affect the disc currently being played. When the disc is removed or the unit is turned off, the subtitle language will revert to the language setting specified through the DVD's main menu.

The subtitle language can also be changed through the DVD's main menu.



Changing the Audio Language

If the disc was created with different language tracks (recorded in different languages), you can use the Info Display to temporarily change the DVD's Audio Language setting.

1. While a disc is playing, press SOUND•ANT on the remote. The current audio language appears in the text box below the row of icons.
2. Press the up/down arrow buttons to scroll through the audio languages that are available on the disc until the audio language you want to use appears in the text box. Audio will be played in that language.
3. To make the Info Display disappear, press the INFO button on the remote.

Notes: The language feature only works if the disc was created with multiple audio tracks.

When you choose an audio language from the Info Display, you only override the audio language setting in the DVD's main menu temporarily.

The audio language can also be changed through the DVD's main menu.



Using the Repeat Feature

The default mode for the Repeat feature is Off. There are four Repeat options:

- Disc – repeats the disc that is playing
- Title – repeats the title that is playing
- Chapter – repeats the chapter that is playing
- A•B – Set the beginning (point A) and the end (point B) to make this part of the movie play repeatedly.

To Use Repeat:

1. While a disc is playing, press INFO on the remote to bring up the Info Display.
2. Highlight the *Repeat* icon. The text in the text box below the icons will read *Repeat Mode: Off*.
3. Press the up/down arrow buttons to scroll through the *Repeat* options until the Repeat option you want is displayed in the text box.
4. Press OK. The selected repeat option will loop repeatedly until you turn Repeat off. Repeat is turned off by completing steps 1 through 3 above, and selecting the Off option.

A•B Repeat

A•B Repeat lets you define a specific segment on the disc that you want to repeat. For example, you might like to watch the dogfight in the movie *Top Gun*. To watch this scene over and over:

1. Find the spot on the disc that is a few seconds **before** the beginning of the scene you want to repeat (this gives you time to access the Info Display and the Repeat feature).
2. Press INFO on the remote and select the *Repeat* icon from the Info Display.
3. Press the up/down arrow buttons until the A•B Repeat option is shown in the text box underneath the icons. The text box reads *Repeat Mode: A-B Press OK to Set A Point*.
4. At the beginning of the scene you want to repeat, press OK to set the A point.
5. When you get to the part of the disc that you want to be the end of the repeated segment (the B point), press OK. The segment will repeat until you turn Repeat off.
6. To make the Info Display disappear from the screen, press the INFO button on the remote.

How to Cancel Repeat

There are three ways to cancel Repeat:

- Press STOP twice.
- Go to the *Repeat* icon in the Info Display and select *Off*.
- Eject the disc.



Using Bookmarks

The bookmark feature lets you mark a point on the disc that you can go to quickly. You can store up to 6 bookmarks per disc. When you turn the TV/DVD off or remove the disc, bookmarks are cleared.

Storing a Bookmark

1. While a disc is playing, press INFO on the remote.
2. Highlight the *Bookmark* icon and press OK.

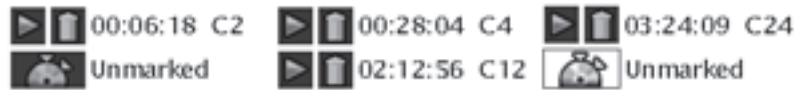

3. The *Bookmark* Menu appears. An available unmarked icon will be highlighted (a disc with two arrows).
4. When you reach the scene you want to mark, press OK. The unmarked icon changes to two icons (side-by-side):
 - An arrow that is used to activate the bookmark.
 - A trash can that is used to clear the bookmark.

Next to the icons, the bookmark start time and chapter are displayed.

5. Press the INFO button on the remote to make the Info Display disappear from the screen.

Using a Bookmark

1. While you're playing a disc, press INFO on the remote.
2. Highlight the *Bookmark* icon and press OK.
3. Highlight the arrow next to the bookmarked scene you want to activate.
4. Press OK to return to the place you bookmarked.
5. To make the Info Display disappear from the screen, press INFO on the remote.

Clearing a Bookmark

The bookmarks are cleared each time a disc is removed from the disc tray or when the power is turned off. If you want to clear a bookmark while the disc is playing:

1. Press INFO on the remote.
 2. Highlight the *Bookmark* icon and press OK.
 3. Highlight the trash can icon next to the bookmark you want to clear. Press OK.
 4. The bookmark is cleared and the trash can icon changes back to the unmarked disc icon.
- If all 6 bookmarks are in use, you can only mark a new scene by clearing an existing bookmark.



Changing the Camera Angle

Some discs contain multiple angles of a particular scene or sequence. If the disc only has one angle, this feature won't work. When multiple angles are available, the *Camera Angle* icon appears in the upper right corner of the screen. To change the camera angle:

1. While a disc is playing, press INFO on the remote.
2. The *Camera Angle* icon will display the number of angles available. For example, if there are 3 different angles, the icon will read 1 of 3. This means angle 1 is currently being played.
3. The text box beneath the icons displays *Camera Angle: 1*. Use the up/down arrow buttons to scroll through the camera angle choices. The camera angle number displayed in the text window is automatically shown.
4. To make the Info Display disappear, press the INFO button on the remote.



Chapter 4: Using the TV's Features



Sample displays on a Channel Banner.

Channel Banner

There are several indicators that might appear when you press the TV or INFO buttons on the remote. This display is called the Channel Banner. The following list describes the items on the Channel Banner screen (left to right and top to bottom).

<i>4/3 format</i>	Displays the current screen format.
<i>Mono</i> <i>(or Stereo)</i>	Mono displayed when the current channel is broadcasting in mono. Stereo displayed when the current channel is broadcasting in stereo.
<i>SAP</i>	Displayed when the current channel is broadcasting SAP (Second Audio Program) information.
	Displayed when the Parental Controls are locked.
<i>CC</i>	Displayed when Closed Captioning is available on the current channel.
<i>03:45 pm</i>	Displays the current time.
<i>15 NBC</i>	Displays the current channel and label assigned to the channel.
<i>Commercial skip 0:30</i>	Displayed to count time remaining on the commercial skip (SKIP) timer.
	Displayed when you mute the sound.

Why You Should Use the Autotuning Feature

The autotuning feature automatically tunes the TV to the correct channel for different components you have connected to your TV/DVD (like a VCR). When you set up autotuning in the menu system you don't have to remember to change your TV to channel 3, for example, when you want to watch the tape in your VCR.

How to Set Up the Autotuning Feature

The way you set up the autotuning feature in the TV's menu corresponds to the component buttons on the remote and the way you have each component connected to your TV/DVD. When you set up autotuning, you're telling the TV what channel to tune to when you press the VCR1, VCR2, or SAT•CABLE button on the remote control.

1. Press MENU (the *MAIN MENU* appears).
2. Highlight *Setup* and press OK on your remote control.
3. Highlight *Autotuning* and press OK.
4. Choose which channel you would like to set:
 - Set VCR 1 Channel* Lets you set up the channel the TV tunes to when you press the VCR1 button.
 - Set VCR 2 Channel* Lets you set up the channel the TV tunes to when you press the VCR2 button.
 - Set SAT/Cable Channel* Lets you set up the channel the TV tunes to when you press the SAT•CABLE button on an RCA satellite receiver remote. (The RCA DTC100 HD receiver is considered a satellite device and can be set up for autotuning using this channel.)
5. Press the right arrow button to select the choice that matches the way you have the component connected to this TV, and press OK.

The choices and a brief explanation follow:

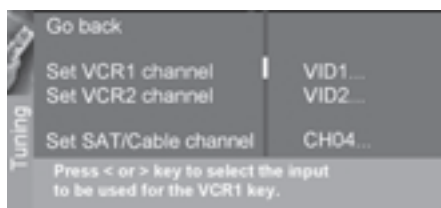

N/A Choose this if you don't have this particular component connected to the TV/DVD, or if you don't want the TV to automatically tune to the correct channel when you're using this component.

Channel 3 or 4 Component is connected to the CABLE/ANTENNA jack on the back of the TV/DVD, and you want the TV to tune to channel 3 when you press the corresponding button on the remote. Reminder: make sure the component's Channel 3/4 switch is set to channel 3.

VID1 or VID2 (Video Input) Component is connected to a VIDEO or S-Video jack on the back of the TV/DVD and you want the TV to tune to a VID input channel when you press the corresponding button.

FRNT (Front Video Input) Component is connected to the VIDEO jack on the front of the TV/DVD and you want the TV to tune to the front VID input channel (FRNT) when you press the corresponding button.

CMP1 or CMP2 (Component Video Input) Compatible component video source, such as a digital TV converter box, is connected to the three COMPONENT VIDEO INPUT jacks (Y,PB,PR) on the back of the TV/DVD and you want the TV to tune to the component video input channel (CMP) when you press the corresponding button.

DVI Component is connected to the DVI-HDCP jack on the back of the TV/DVD and you want the TV to tune to the DVI input channel when you press the corresponding button.

Parental Controls and V-Chip

The first three choices in the *Parental Controls* menu involve software inside your TV (referred to as V-Chip) which allows you to block TV programs and movies based on violence, sex, or other content you may believe children should not view.

Once you block programs, you can unblock programs by entering a password.

By default, the software inside your TV is turned "off."

Note: Parental Control settings are not available for DVI, CMP1 or CMP2 inputs.

How V-Chip Works

V-Chip reads the program's age-based rating (TV-MA, TV-14, etc.) and content themes [(Violence (V), Adult Language (L), etc.)]. If you have blocked the rating and/or content themes that the program contains, you will receive the message *This channel is not approved for viewing*.

Broadcasters are not required to provide content themes, so programs received with no content themes will only be blocked if you block their age-based rating. You can also block out programs that have been given a rating of "Not Rated," and programs that are considered "unrated." The TV age-based ratings and content themes you can block are listed in the following table.

Age-Based Rating	Description and Content Themes for Age-Based Ratings
TV-MA	Mature Audience Only. Specifically designed to be viewed by adults and may be unsuitable for children under 17. It contains one or more of the following content themes: crude indecent language (L), explicit sexual activity (S), or graphic violence (V).
TV-14	Parents Strongly Cautioned. Contains some material that many parents would find unsuitable for children under 14. Parents are strongly urged to exercise greater care in monitoring this program and are cautioned against letting children under the age of 14 watch unattended. This program contains one or more of the following content themes: intensely suggestive dialogue (D), strong coarse language (L), intense sexual situations (S), or intense violence (V).
TV-PG	Parental Guidance Suggested. Contains material that parents may find unsuitable for younger children. Many parents may want to watch it with their younger children. The program contains one or more of the following content themes: some suggestive dialogue (D), infrequent coarse language (L), some sexual situations (S), or moderate violence (V).
TV-G	General Audience. Most parents would find this program suitable for all ages. It contains little or no sexual dialogue (D) or situations (S), no strong language (L), and little or no violence (V).
TV-Y7	Directed to Children 7 years and older. Designed for children ages 7 and above. It may be more appropriate for children who have acquired the developmental skills needed to distinguish between make-believe and reality. Themes and elements in this program may include mild fantasy violence (FV) or comedic violence, or may frighten children under the age of 7.
TV-Y	All Children. Themes and elements in this program are designed for a young audience, including children from ages 2-6. It is not expected to frighten younger children.



V-Chip TV Rating

The *V-Chip TV Rating* lets you decide which TV programs can and cannot be viewed.

To set TV programming limits:

1. Choose *Parental Control* from the Main menu. If Parental Controls have previously been locked, you must enter your password.
2. Press OK to continue.
3. Highlight and select V-Chip TV rating.
4. Once you get to the *V-Chip TV rating limit* screen, use the arrow buttons and OK on your remote to change the status of a TV program rating or content theme from *View* to *Block*.
5. For TV rating limits to take effect, lock Parental Controls by accessing the *Lock parental controls* menu.

The following sections give you more details about how to change the status of TV program limits.

Using the TV's Features

The V-Chip Rating Screen

The following is an example of where items are located within the Rating Limit screen.

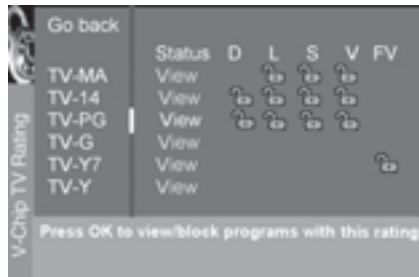
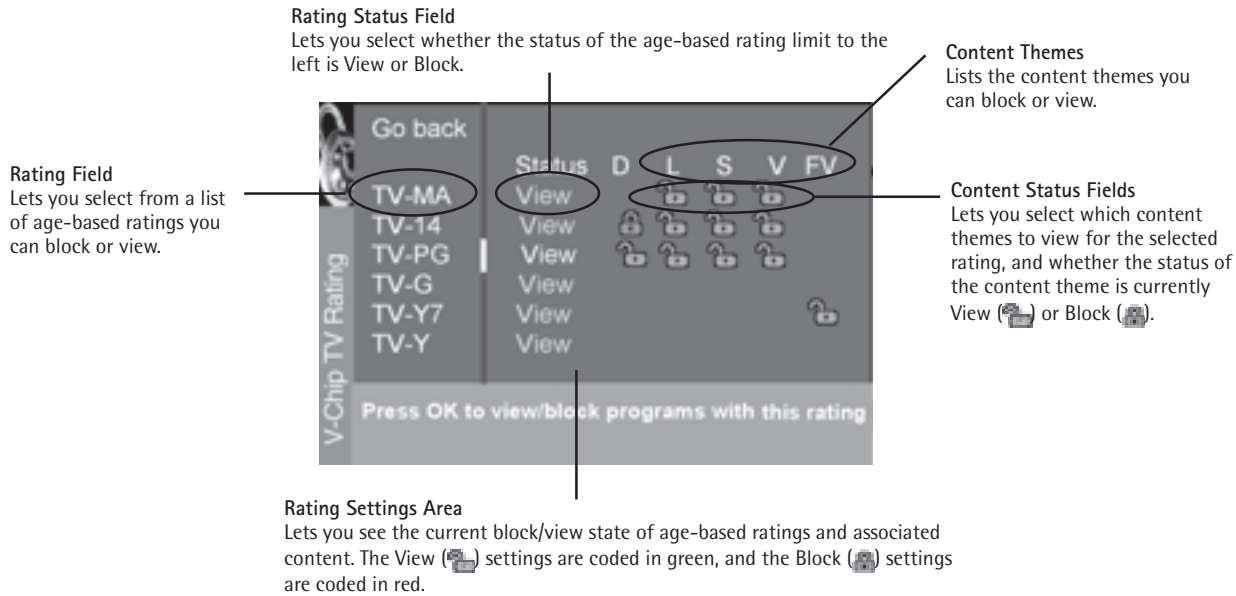

Blocking Age-Based Ratings

You can automatically block all program ratings above a specified age-based rating level.

To block programs with higher ratings:

1. Press the up or down arrow button to scroll to the rating corresponding with the lowest rating you do not want the child to watch.
2. Press the OK button to toggle between *View* and *Block*. The status for the rating listed to the left and all higher ratings automatically changes to *Block* (and 🔒).
3. Press the up or down arrow button to highlight *Go back* and press OK.
4. Select *Lock Parental Controls* from the *Parental Control* menu for rating limits to take effect.

Hierarchy of Age-Based Ratings	
TV-MA	Mature Audience Only
TV-14	Parents Strongly Cautioned
TV-PG	Parental Guidance Suggested
TV-G	General Audience
TV-Y7	Directed to Children 7 years and older
TV-Y	All Children

Viewing Age-Based Ratings

After you block age-based ratings, you can change some of the ratings back to *View*.

1. Press the up or down arrow button to select the rating with a status of *Block*.
2. Press OK to select *View*.

Content Themes	
D	Sexually explicit dialogue
L	Adult language
S	Sexual situations
V	Violence
FV	Fantasy Violence

Blocking Specific Content Themes

You can block programs based on their content. (Content is represented by the D, L, S, V and FV on your screen.) When you block a content theme for a particular rating, you automatically block that content theme for higher rated programs as well.

To block program content:

1. Determine the content themes you want to block.
2. Press the down arrow button to scroll to the rating whose content theme you want to change.
3. Press the right arrow button to move the yellow highlight to a particular content theme status.
4. Press the OK button to change its status to 🔒 (In the example to the left, you block the language (L) corresponding with TV-14. The language for TV-MA is blocked as well.)

Notes: Broadcasters are not required to provide content themes or age-based ratings.

You must remember to lock Parental Controls for rating limits to take effect.

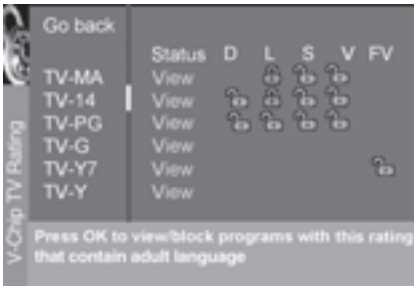

Tip

To change all V-Chip movie or TV ratings to View, press the 0 number button.

Viewing Specific Content Themes

If you block specific content themes, you have the option of going back and changing some of the content themes back to (V) View:

1. Determine the content themes you want to change to (V) View.
2. Press the down arrow button to scroll to the rating whose content theme you want to change, such as (L) under language (L) corresponding with TV-14.
3. Press the right arrow button to move the yellow highlight to a particular content theme status.
4. Press the OK button to change the status back to (V). Your child would then be able to watch programs with the TV-14 adult language content, but not programs with TV-MA language content.

Note: Only the content theme status corresponding to TV-14 (L) language changes to (V) View. Higher rated content themes, such as that for TV-MA language, do not change.

V-Chip Movie Rating Limit

Set movie rating limits by blocking movies rated above a specified level.

To change menu:

1. Press MENU on the remote control (the TV MAIN MENU appears).
2. Select *Parental Control*.
3. Select *V-Chip movie rating*.

Blocking Movie Ratings

Once you are in the Movie Ratings menu, follow the same steps described for blocking TV ratings.

V-Chip Unrated Program Block

This option lets you decide if programs that the V-Chip recognizes as "unrated" can be viewed. "Unrated" TV programs may include news, sports, political, religious, local and weather programs, emergency bulletins, public announcements, and programs without ratings.

View All unrated programs are available.

Block All unrated programs are not available.

Note: You must remember to lock Parental Controls for rating limits to take effect.

Press the down arrow to highlight V-Chip unrated. Then press the right arrow to switch between Block and View.

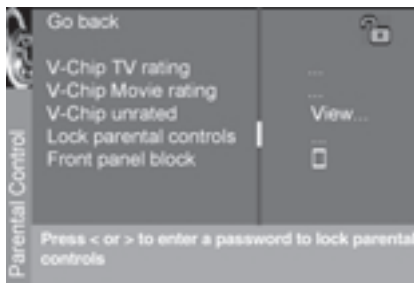

Lock/Unlock Parental Controls

Selecting this option lets you lock and unlock parental controls settings using a password.

If you do not lock parental controls, none of the settings for V-Chip, Channel Block, or Front Panel Block will take effect.

If you forget your password, press the MENU button, then select *Parental Control* (the password entry screen appears). Simultaneously press and hold CH+ and VOL+ on the television for 3 seconds. Parental Controls unlock and the *Parental Control* menu appears so you can enter a new password.

Front Panel Block

Selecting this option lets you block (disable) or unblock (enable) the TV/DVD's front panel. The remote still tunes to any channel. When using this as a Parental Control method, remove access to any remote that is capable of operating the television while you have the front panel blocked.

Don't forget to lock parental controls after you change the status. If you don't, the front panel block will not take effect.

PIP (Picture-in-Picture) and POP (Picture-outside-Picture) Operation

The PIP (picture-in-picture) feature lets you display a second, smaller picture on top of the main picture. POP (picture-outside-picture) lets you display two windows side by side.

Note: PIP and POP are not available for DVI or component video sources (CMP1 or CMP2).



PIP example



POP example

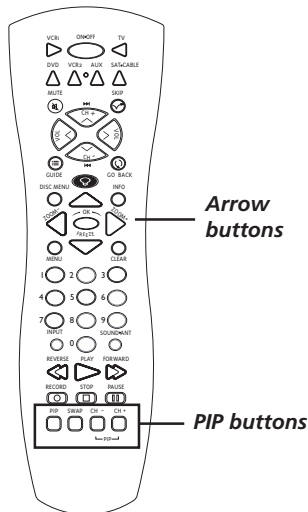

PIP and POP Buttons

There are several remote buttons that control the way the PIP window works:

PIP Brings up the PIP window. Press again to bring up POP. Press again to remove the window.

Up and down arrow buttons Let you move the PIP window to different corners of the screen. Up arrow moves PIP counterclockwise; down arrow moves PIP clockwise.

Left and right arrow buttons Switches the left POP window to the right side, and the right POP window to the left.

SWAP Switches, or "swaps," the video from the PIP window with the main picture. Switches the main POP window, where the sound is coming from, with the other window.

PIP CH+ and CH- Lets you change channels in the PIP and right POP picture.

The DVD's Menu System

The DVD's menu system is not the same as the disc menu or the Info Display. The DVD's main menu comes up when there is no disc playing. If you are playing a disc, press STOP on the remote control to stop playback and bring up the DVD's main menu.



Press OK to clear the screen and resume play.

The Play/Resume Play Option

To get to the DVD's main menu, press STOP on the remote control. The first item in the main menu is the *Play/Resume Play* option. If there isn't a disc in the TV/DVD, the option reads *Play* with the prompt *Insert Disc* to the right. If there is a disc in the TV/DVD and it was previously playing, the option reads *Resume Play* and the name of the disc is displayed on the right.

Any time you stop playback, you will be returned to the DVD's main menu, and the *Play* option will read *Resume Play*. To resume play, highlight the option and press OK, or press the PLAY button on the remote.

The Play Mode Menu

The DVD's *Play Mode* menu lets you choose different ways to play the disc. To see *Play Mode* menu options, a disc must be in the TV/DVD.

1. If the disc is playing, press STOP (the DVD's main menu appears).
2. Highlight the *Play Mode* menu option.
3. Press OK. The *Play Mode* menu items appear.
4. Highlight the desired option and press OK. *Program Play* will not work unless you have created a program list.

Selecting a Play Mode

The first three options in the *Play Mode* menu determine in what order the titles or tracks will play on a disc.

Standard Play: plays the disc's titles and chapters in their default order (i.e., chapter 1 of Title 1 plays first, then chapter 2 of Title 1, etc.)

Random Play: plays the chapters of each title in random order.

Program Play: Plays the chapters on the disc in the order you have programmed (you must select *Edit Program* and set up the order in which you want the tracks on the disc to play).



Selecting *Random Play* plays the disc's tracks in random order.

How to Create a Program

To use the *Program Play* option, you must create a program list to set the order in which you want titles and chapters on a DVD video disc to play. To create a program list for an Audio CD or MP3 go to Chapter 7.

Creating a Program List for a DVD Video Disc

1. If the disc is playing, press STOP to stop playback (the DVD's main menu appears).
2. Highlight *Play Mode* and press OK (the *Play Mode* menu appears).
3. Highlight *Edit Program* and press OK (the *Edit Program* screen appears).
4. The *Title* box is highlighted. Use the up/down arrows or the number buttons on the remote to enter the title you want to play first. The title number you entered appears in the *Title* box. The number of chapters available appears under the *Chapter* box.
5. Highlight the *Chapter* box and use the up/down arrows or the number buttons on the remote to enter the chapter you want to play first and press OK. The highlight jumps to the *Add* button.
6. Press OK to add that chapter to the *Program List*. The highlight jumps back to the *Title* box so you can add more titles and/or chapters. Make sure the *Title* box is highlighted and enter your next title and/or chapter.
7. Continue adding titles/chapters as explained in steps 4–6 until your program is complete. You can play your program by highlighting *Play* and pressing OK, or you can save the program by highlighting *Done* and pressing OK. The program will be erased when you remove the disc from the TV/DVD.

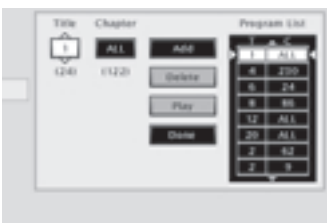

When the *Title* box is highlighted, enter the title number you want to place in the list.



To delete an entry from the playlist, highlight it, then highlight *Delete* and press OK.

Editing a Program

Deleting Chapters

To delete chapters from the playlist:

1. If the disc is playing, press STOP to stop playback (the DVD's main menu appears).
2. Highlight *Play Mode* and press OK (the *Play Mode* menu appears).
3. Highlight *Edit Program* and press OK (the *Edit Program* screen appears).
4. Highlight the item in the playlist you want to delete.
5. Highlight *Delete*, and press OK.
6. When you are finished rearranging the playlist, highlight *Done* and press OK.

Inserting Chapters

To insert chapters into the playlist:

1. If the disc is playing, press STOP to stop playback (the DVD's main menu appears).
2. Highlight *Play Mode* and press OK (the *Play Mode* menu appears).
3. Highlight *Edit Program* and press OK (the *Edit Program* screen appears).
4. Use the left/right arrow keys to move the highlight to the program list. Use the up/down arrow keys to mark the spot in the playlist where you want to insert a chapter (the inserted chapter will be placed *before* the highlighted chapter).
5. Highlight the *Chapter* box and use the up/down arrows or the number buttons on the remote to enter the chapter you want to play first.
6. Once you enter the number, the *Insert* box is highlighted. Press OK to insert the chapter in the playlist.
7. When you are finished rearranging the playlist, highlight *Done* and press OK.

AutoPlay

You can set the AutoPlay option to play your disc automatically after you close the disc tray.

1. From the DVD's main menu (in DVD mode, no disc playing) highlight the *Play Mode* option and press OK.
2. The Play Mode selections appear. Highlight the AutoPlay option and press OK to toggle the option on/off.
3. Press the left arrow button to return to the previous menu or press GO BACK to return to the main menu.

Dub Assist

Dub Assist helps you record a CD onto an audio cassette tape by determining the number of tracks that will fit on one side of the tape so you have time to turn the tape over to record on the other side. For steps on how to use Dub Assist go to Chapter 7.

IntroScan

IntroScan plays the first 10 seconds of each track on an Audio CD or MP3 file. IntroScan will not repeat automatically. Once it has completed, the system will stop the disc and return to the main menu.

To use IntroScan when playing a CD or MP3:

1. Highlight *Play Mode* and press OK.
2. Highlight *IntroScan* and press OK to begin the function.
3. Press STOP to stop the IntroScan function.

The Lock Menu

The padlock icon is displayed on the DVD's main menu which shows whether your DVD is locked or unlocked.



Locked: A password is needed in order to play discs that aren't included in the rating limits you have set. When the DVD is locked, no one can access the *Lock Menu* items without entering the password.



Unlocked: A password isn't required to play discs.



Use the numbers on the remote to enter a password.

Locking Your DVD

1. If the disc is playing, press STOP (the DVD's main menu appears).
2. Highlight *Lock* and press OK (the *Lock* menu items appear).
3. Highlight *Lock Player* and press OK. The *Enter New Password* screen appears.
4. Press the number keys on the remote to enter the password you want to use (similar to entering your PIN when you use a bank machine).
5. After you've entered the last number in the password, press OK. *Confirm Password* appears.
6. Enter the numbers you entered the first time and press OK when you're finished.
7. Press the left arrow to return to the main menu.

Unlocking Your DVD

1. If the disc is playing, press STOP (the DVD's main menu appears).
2. Highlight *Lock* and press OK.
3. The *Enter Password* box appears. Enter your password and press OK (the *Lock* menu options appear).
4. Highlight *Unlock Player* and press OK. The locked icon changes to unlocked.

If you forget your password, simultaneously press and hold OPEN/CLOSE and the STOP on the TV/DVD's front panel for 2 seconds. Enter a new password via the *Lock* menu .

Changing Your Password

The DVD must be locked to change the password.

1. If the disc is playing, press STOP (the DVD's main menu appears).
2. Highlight *Lock* and press OK. *Enter Password* appears on the screen. Enter your password.
3. Highlight *Change Password* and press OK. *Enter New Password* appears.
4. Press the number buttons on the remote to enter the new password you want to use and press OK. *Confirm Password* appears.
5. Press the number keys to enter the password again and press OK when you're finished.

Setting the Ratings Limits

The Ratings Limits feature is a rating limit system, sort of like movie ratings. It works with DVD discs that have been assigned a rating. This helps you control the types of DVDs that your family watches.

Note: When in DVD mode, the TV/DVD alerts you when you try to play a movie with a rating that exceeds the limit you've set. Some discs include a rating override feature. When you play a disc with this feature, the message Override Limit or Cancel Selection appears on the screen. If you choose to override the rating limit, you will need to enter your password to begin playback.

Changing to a Different Country's Rating System

Some countries use different rating systems. The default for this TV/DVD is the United States. You can change to a different country's rating system through the *Lock* menu.

1. If the disc is playing, press STOP (the DVD's main menu is displayed).
2. From the main menu, highlight the *Lock* option and press OK (the *Lock* menu appears).
3. Highlight *Ratings Limits* and press OK (the *Ratings Limits* menu appears).
4. Highlight *Country* and press OK (a list of countries appears).
5. Highlight the country you want to change to and press OK (the country you selected appears next to the *Country* path menu).
6. Press the left arrow key to return to the main menu.

Rated Titles

The *Rated Titles* option lets you determine how your DVD will react to discs that contain movies that are rated (in the U.S.A., the Motion Pictures Association of America rates movies as G, PG, PG-13, etc.).

You decide which ratings require a password and which ones don't. This system ranks the ratings 1 through 8 in order to accommodate different countries' ratings systems (1 is considered a movie title with the least offensive material).

In order for the Rating Level feature to work, the disc must be encoded with rating information. If the author of the disc did not encode rating information, then this feature will not work for that disc.

When in DVD mode, the TV/DVD must be locked in order for it to enforce the settings in the *Ratings Limits* part of the *Lock* menu.

Using the DVD Menu



The Rated Titles screen lets you set the Rating Limit

1. From the *Lock* menu, highlight *Ratings Limits* and press OK (the *Ratings Limits* menu is displayed).
2. Highlight *Rated Titles* and press OK (the 8-level rating limits list appears).
3. To change the rating limit, press the up or down arrow button.
 - The ratings that don't require a password (free access) appear under the bar, in the green part of the block.
 - The ratings that require a password appear above the bar, in the red part of the block.
4. When you have moved the bar to the desired setting, press OK. You are returned to the *Rated Titles* screen and the setting appears to the right of the *Rated Titles* option. For example, if you set 3 as the highest rating for Free Access (green), then the *Rated Titles* selection appears as 3 (that's the DVD's number for PG in the 8-level system) for the movie studio's rating. This means when the DVD is locked, it will require you to enter the password to play any discs that are rated higher than 3 (i.e., PG-13 or NC-17).
5. Press the left arrow button to return to the main screen.



Choose Unrated Titles to set free access or require a password for unrated titles.

Unrated Titles

Some titles (movies) aren't rated, but may contain material that is unsuitable for children. You decide how you want the *Ratings Limits* feature to handle these discs: free access or password required. To set the *Unrated Titles* option:

1. From the Lock Menu, highlight *Ratings Limits* and press OK.
2. Highlight *Unrated Titles* and press OK. The *Unrated Titles* options appear.
3. Use the up/down arrow buttons to highlight your choice: *Free Access* or *Password Required*. Press OK. You are returned to the previous screen, and the option you chose is displayed next to the *Unrated Titles* option.
4. Press the left arrow key to return to the main menu.

System Test

There are several tests you can run from the System Test menu. If a problem is found, the text will appear in light gray.

1. Highlight *System Test* within the *Lock* menu.
2. Press OK to display the *System Test Results* screen.
3. Press the left arrow key to return to the main menu.

The Display Menu

The *Display* menu contains the settings that affect how disc content looks on your TV/DVD.

TV Image

The *TV Image* menu adjusts the way a movie appears on your TV/DVD.

1. From the DVD's main menu (in DVD mode, no disc playing), highlight *Display* and press OK (the *Display* options appear).
2. Highlight *TV Image*. Press OK. The *TV Image* options appear.

4 x 3 Letterbox – Choose this setting when receiving a 4:3 image with subtitles ON. You'll see the entire frame of the movie, but it will take up a smaller portion of the screen vertically to accommodate subtitles. The movie might appear with black bars at the top and bottom of the screen.

4 x 3 Standard – Choose this setting when receiving a 4:3 image and you want the on-screen appearance of the video to be a centered picture with black side panels (blank area) on the right and left sides. Most discs produced in a widescreen format can't be cropped in this fashion. This means the black bars appear at the top and bottom of the screen.

16 x 9 Standard – Choose this setting to view 16:9 formatted DVD's. Most DVD's will force the viewing to this mode. Also choose this if you want a 4:3 image to adjust horizontally to fill the 16:9 screen. Black side panels won't be added, and the image is vertically unaltered.

On-Screen Displays

This feature lets you select whether you want certain on-screen displays to appear on the screen. It contains three choices with check boxes next to them:

- Information Display – When turned on, displays time transport information when you are fast forwarding or reversing playback.
- Angle Indicator – When turned on, displays camera angle icon if more than one camera angle is available.
- Scene Again™ Text – When turned on, displays subtitles when you use the Scene Again™ feature.

The default is to show all on-screen displays. To turn one of the options on or off, highlight an option and press OK. This toggles the option on or off.

The Sound Menu

The *Sound* menu lets you select different sound settings to match the equipment you have connected to your unit.

Digital Output

Digital output lets you choose which type of digital audio is output from your unit. If you've used an optical cable to connect a Dolby Pro Logic, Dolby Digital, or DTS receiver, you must adjust this setting. There are two options:

- Dolby Digital: Choose this setting if you connected a Dolby Digital receiver.
- DTS: Choose this setting if you connected a DTS receiver or decoder to your unit.

The default is Dolby Digital. To change the digital output:



Select the Digital Output option from the Sound menu.

1. From the main menu, highlight and select the *Sound* option and press OK (the *Sound* menu is displayed).
2. Highlight the *Digital Output* option and press OK.
3. Highlight the desired output and press OK.
4. Press the left arrow key to return to the main menu.

Notes: If you set Digital Output to DTS, you must have your unit connected to a receiver or decoder with the DTS feature and the disc you play must support the DTS audio format. If you choose DTS and your receiver or decoder doesn't support DTS, you won't hear any audio.

If you don't want to make any changes, press CLEAR to return to the main menu or GO BACK to return to the Speaker Setup menu.

Sound Logic

The Sound Logic feature compresses the dynamic range (quietest sound to loudest sound) of a disc's soundtrack. For example, action scenes might be very loud, while whispered dialog is quiet. The Sound Logic feature evens out the range of the volume by making loud sounds quieter and soft sounds louder. The Sound Logic option is a toggle, it can be turned on or off.

The default setting is off. To turn the Sound Logic feature on:

1. From the DVD's main menu, highlight *Sound* and press OK (the *Sound* menu appears).
2. Highlight the *Sound Logic* option and press OK.
3. Press the left arrow button to return to the main menu.

Note: The performance of the Sound Logic feature varies depending on the type of equipment you have connected to your TV/ DVD and the audio format of the disc you're playing.



Select the Sound Logic option from the Sound menu and press OK to toggle Sound Logic on or off.

The Languages Menu

The *Languages* menu enables you to choose different language options for audio, subtitles, Disc Menu items and DVD main menu items. The default for all Language menu items is English.

Changing the Player Menus, Disc Menus, Audio or Subtitles Language Preferences

You can choose one of the languages for the text that appears within the on-screen menu system.

1. From the main menu, highlight and select the *Languages* option (the *Languages* menu is displayed).
2. Highlight the language option for the language you want to change and press OK (the language choices are displayed).
3. Highlight the language you want to use and press OK. The menu appears with your selection shown next to the language option.
4. Press the left arrow button or press GO BACK to return to the previous menu.

Notes: If you change the Player Menu Language, the entire DVD's menu system will be displayed in the selected language.

The option Original in the Audio Language menu is the language in which the audio was originally recorded.

How to Set Other in Disc Menus, Audio or Subtitles Language

If the language you want to use isn't listed, you can use the *Other* option to select the language of your choice.

1. From the main menu, highlight and select the *Languages* option (the *Languages* menu is displayed).
2. Highlight the language option you want to change to Other and press OK (the language options are displayed).
3. Highlight *Other* and press OK.

(steps continued on next page)

Using the DVD Menu

4. Enter the code from the Language Codes list at the end of this chapter and press OK (the previous menu appears with your selection shown next to the language option you changed).
5. Press the left arrow button or press GO BACK to return to the previous menu screen.

Note: Remember, your TV/DVD can't play the disc in the language you have chosen if the disc wasn't created with that language option.

Glossary

The glossary contains definitions and information about the features and controls when in the DVD mode.

1. If the disc is playing, press STOP (the DVD's main menu appears).
2. Highlight *Glossary* and press OK (the Glossary appears).
3. Use the arrow buttons on your remote to highlight different terms. The definitions appear on the right side of the screen. Some glossary definitions are more than one page. The scroll icon appears in the definition box to let you know when there's a second page. To see the rest of the definition:
 - a. Press the right arrow button. The glossary definition is highlighted.
 - b. Press the down arrow button. The second page of the definition appears.
 - c. Press the up arrow button to return to the first page of the definition or press GO BACK to return to the main menu.
4. Press the left arrow button to return to the DVD's main menu.

Code List **Don't forget to press the OK button after you enter the code.**

Language	Code	Language	Code	Language	Code	Language	Code
Abkhazian	6566	French	7082	Lithuanian	7684	Sindhi	8368
Afar	6565	Frisian	7089	Macedonian	7775	Singhalese	8373
Afrikaans	6570	Galician	7176	Malagasy	7771	Siswati	8383
Albanian	8381	Georgian	7565	Malay	7783	Slovak	8375
Ameharic	6577	German	6869	Malayalam	7776	Slovenian	8376
Arabic	6582	Greek	6976	Maltese	7784	Somali	8379
Armenian	7289	Greenlandic	7576	Maori	7773	Spanish	6983
Assamese	6583	Guarani	7178	Marathi	7782	Sundanese	8385
Aymara	6588	Gujarati	7185	Moldavian	7779	Swahili	8387
Azerbaijani	6590	Hausa	7265	Mongolian	7778	Swedish	8386
Bashkir	6665	Hebrew	7387	Naru	7865	Tagalog	8476
Basque	6985	Hindi	7273	Nepali	7869	Tajik	8471
Bengali; Bangla	6678	Hungarian	7285	Norwegian	7879	Tamil	8465
Bhutani	6890	Icelandic	7383	Occitan	7967	Tatar	8484
Bihari	6672	Indonesian	7378	Oriya	7982	Telugu	8469
Bislama	6673	Interlingua	7365	Oromo (Afan)	7977	Thai	8472
Breton	6682	Interlingue	7369	Panjabi	8065	Tibetan	6679
Bulgarian	6671	Inupiak	7375	Pashto, Pushto	8083	Tigrinya	8473
Burmese	7789	Irish	7165	Persian	7065	Tonga	8479
Byelorussian	6669	Italian	7384	Polish	8076	Tsonga	8483
Cambodian	7577	Japanese	7465	Portuguese	8084	Turkish	8482
Catalan	6765	Javanese	7487	Quechua	8185	Turkmen	8475
Chinese	9072	Kannada	7578	Rhaero-Romance	8277	Twi	8487
Corsican	6779	Kashmiri	7583	Romanian	8279	Ukrainian	8575
Croatian	7282	Kazakh	7575	Russian	8285	Urdu	8582
Czech	6783	Kinyarwanda	8287	Samoan	8377	Uzbek	8590
Danish	6865	Kirghiz	7589	Sangho	8371	Vietnamese	8673
Dutch	7876	Kirundi	8278	Sanskrit	8365	Volapük	8679
English	6978	Korean	7579	Scots Gaelic	7168	Welsh	6789
Esperanto	6979	Kurdish	7585	Serbian	8382	Wolof	8779
Estonian	6984	Laothian	7679	Servo-Croatian	8372	Xhosa	8872
Faroese	7079	Latin	7665	Sesotho	8384	Yiddish	7473
Fiji	7074	Latvian, Lettish	7686	Setswana	8478	Yoruba	8979
Finnish	7073	Lingala	7678	Shona	8378	Zulu	9085

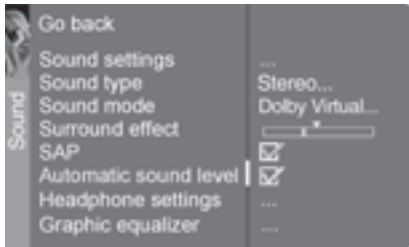

Sound Menu

Sound settings Displays a choice list that lets you adjust the TV/DVD's speakers and subwoofer.

Left & Right balance Use the left or right arrow to center the bar under the arrow to balance the left and right speakers.

Amplifier Use the left or right arrow to select *External* (if your TV/DVD is using external amplifier only) or *Internal* (if your TV/DVD is using the speakers in the TV/DVD).

Subwoofer Set the subwoofer to *External*, if the TV/DVD is using an external subwoofer; or *None*.

Sound type Press the right arrow to scroll through the available audio types, which control the way the sound comes through your speakers.

Mono Plays the sound in mono only. Use this setting when receiving broadcasts with weak stereo signals.

Stereo Splits the incoming stereo audio signal into left and right channels. Most TV programs and recorded materials have stereo audio. The word Stereo appears on the TV/DVD when you tune to a program that is broadcast in stereo.

Automatic Chooses the sound type according to the current signal.

Sound Mode Press the right arrow to scroll through the available audio modes, which provides special processing through your speakers and depends on how you set the sound type.

Normal Does not give any special processing, simply provides mono or stereo sound.

Wide Available only for mono signals. "Widens" sound from mono broadcasts and mono components connected to your TV/DVD for a fuller, more spacious sound.

Magic Available only for stereo signals. Gives a surround effect with more bass.

Dolby Virtual Available only for stereo signals. Creates a virtualized surround sound experience from two speakers using the Dolby Pro Logic decoding. It provides the sensation of being surrounded by additional speakers.

Surround effect Controls the amount of surround sound in Dolby Virtual sound mode.

Second Audio Program (SAP) Plays the program's audio in a second language, if one is available. The TV/DVD displays the word SAP when you tune to a program that is broadcast with SAP information. SAP audio is broadcast in mono. SAP is also used to broadcast a program's audio with descriptions of the video for the visually impaired.

Automatic sound level Reduces the annoying blasts in volume during commercial breaks, and also amplifies softer sounds in program material. Eliminates the need to constantly adjust volume control.

Headphone settings Displays a choice list of available settings you can adjust: *Volume*, *Bass* and *Treble*. The *Headphone sound option* allows you to choose stereo, mono or automatic. These descriptions are same as sound type above.

Graphic equalizer Allows you to choose a specific sound through the *Sound Preset* option. Press the right arrow to cycle through the options: *Standard*, *Movie*, *Voice*, *Music*, *Flat*, *Videogame*, *Video camera* and *Personal*.

The *Frequency range* displays the different treble and bass bands set for each *Sound Preset* option. You can choose a band and make adjustments. When you make adjustments, the *Sound Preset* option automatically changes to *Personal*. Press the left or right arrow button to select the frequency (Bass 100Hz, Mid Bass 500Hz, Medium 1.5kHz, Mid Treble 5kHz, Treble 10kHz) you want to adjust. Then use the up or down arrow button to adjust the decibel.

To view the frequency range of another *Sound Preset* option, press the right arrow until no band is selected and *Frequency range* is highlighted. Then press the up arrow to highlight *Sound Preset*.

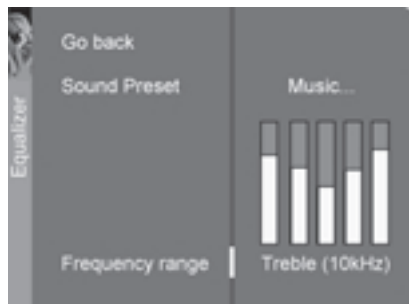

Picture Menu

The Picture menu options apply to the video for the main TV and video input selections.

Advanced picture settings

Contrast expand Adjusts the contrast of the picture according to the light of the room. Press the right arrow to choose between *Low*, *Medium* or *High*.

SVM (Scan Velocity Modulation) Improves the sharpness of the picture by changing the speed of the cathode-ray tube's electron beam when it transitions between dark and light areas of the screen. Choose to have it on (box checked) or off (box unchecked), depending on your preference.

Autoformat When enabled (box checked) the TV automatically detects the screen format the signal is sending for each channel, as well as input channels.

Using the TV's Menu System

Video noise reduction Allows you to choose a setting to reduce picture "static" or any type of interference. It is especially useful for providing a clearer picture in weak analog signal conditions. Press the right arrow to choose between: *Off* for no noise reduction; *Minimum* for a softer, smoother picture and retains picture sharpness and detail; *Medium* for a slightly softer picture than the Minimum setting; *Maximum* for an even softer, smoother picture than the other settings. However, the picture detail is somewhat decreased.

Note: Autoformat and Video noise reduction are available for DVI, CMP1 and CMP2 inputs if the signal is 480i.

Picture Presets Displays a choice list that lets you select one of the preset picture settings: *Movie*, *Videogame*, *Personal*, *Sports*, *Ideal*, *Showroom* or *Video Camera*. Choose the setting that is best for your viewing environment.

Black Level Adjusts the brightness of the picture.

Color Adjusts the richness of the color.

Contrast Adjusts the difference between the light and dark areas of the picture.

Sharpness Adjusts the crispness of the edges in the picture.

Note: You can adjust sharpness for each channel. This is useful if channels appear fuzzy.

Color Warmth Displays a choice list that lets you set one of three automatic color adjustments: *Cool* for a more blue palette of picture colors; *Normal*; and *Warm* for a more red palette of picture colors. The warm setting corresponds to the NTSC standard of 6500 K.

Tint Adjusts the balance between the red and green levels.

Note: Tint not available for DVI, CMP1 and CMP2 inputs.

When you change any of these picture settings, the Picture Preset changes to personal. Use the left or right arrow button to make adjustments. To return to the Picture menu, press the up or down arrow button.



Channel Guide Menu

Allows you to view and select from the entire channel list and their labels. Press the GUIDE button to bring up the Channel Guide menu. Use the up or down arrow to scroll through the list. Press OK to select and tune to the chosen channel.

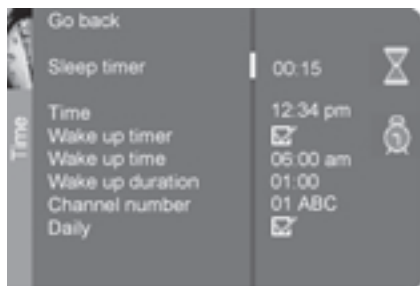

Time Menu

Sleep Timer Lets you set the TV to turn off after a given time.

Time Lets you enter the current time. If it is eight o'clock, for example, you must first enter the number zero, then number eight. Use the OK button to choose between AM and PM.

Wake up timer Lets you set the TV to turn itself on. When you turn on *Wake up timer*, the following options appear:

Wake up time Lets you set the time you want the TV to turn itself on.

Wake up duration Lets you set how long you want the TV to stay on when it turns on.

Channel number Lets you select a specific channel the TV tunes to when the wake up timer is set.

Daily Lets you choose if you want the wake up timer to turn on daily.

Parental Control Menu

The Parental Control Menu was explained in Chapter 4. Go to page 23 for more information.



PIP Menu

Display Mode

Off No window is displayed.

PIP PIP (single) window is displayed.

POP POP (double) window is displayed.

PIP channel Allows you to choose the channel displayed in the PIP or main POP window. Scroll through channel list as well as the VID1, VID2 and FRNT input channels.

PIP size Allows you to choose having a *Small*, *Medium* or *Large* PIP window.

PIP position Allows you to choose having the PIP window in the *Top right*, *Top left*, *Bottom right* or *Bottom left* part of TV.

Note: Pip size and position are not available for POP.



Setup Menu

Channel setup

Signal Type TV chooses signal type during initial setup. If you change cable after setup, choose Cable if you are using cable or a cable box for TV signals. Choose UHF/VHF Antenna if you are using an off-air antenna for TV signals.

Auto channel search Searches for channels the signal is receiving. Go to page 13 for more information.

Auto channel update Searches for any new channels that are not in your channel list and adds them to the list.

List and labels Edit the channels in the list or choose labels for each channel. Go to page 13 for more information.

Preferences

Language Displays a choice list that lets you select your preferred language for the menus: *English, Spanish* or *French*.

Maximum volume Allows you to set how high volume turns up when you press the VOL+ button. Highlight *Maximum volume*, then press and hold OK to hear is the maximum volume. Make sure the volume has not been muted or turned all the way down.

Curtain effect Reveals or hides the picture by giving it a "stage curtain" effect when the TV is switched on or off.

Special features *Auto on* switches your TV on after a power outage; *Auto channel* tunes the TV to the channel you specify as the *Initial channel* when Auto on is enabled; *Auto volume* tunes the TV to the volume you set in *Initial volume* when Auto on is enabled.

Closed Caption Many programs are encoded with closed-captioning information, which lets you display the audio portion of a program as text on the TV screen.

Closed-captioning is not available on all channels at all times. Only specific programs encoded with closed-captioning information are applicable. When a program is closed captioned, CC is displayed in the channel banner. See Chapter 4 for more information about the channel banner. The closed caption options are:

Closed caption setting Displays a choice list that lets you choose the way closed captioning information is shown on the screen. Closed-captioning is not available with the high resolution input.

Off No captioning information displayed.

On always Captioning information shown always, when available.

On when mute Displays captioning information, when available, whenever the TV's sound is muted by pressing the MUTE button. The captioning information is not displayed when the sound is not muted.

Closed-Caption Mode Displays a choice list that lets you choose which captioning mode is used for displaying captioning information. If you are unsure of the differences among the modes, you may prefer to leave the closed captioned mode set to CC1, which displays complete text of the program in the primary language in your area.

Autotuning Displays a choice list that lets you set up the TV to automatically tune to the correct input channel when you press a component button (VCR1, DVD, VCR2, SAT•CABLE, etc.) on the remote. Go to Chapter 4 for details about the Autotuning feature.

Convergence *Auto convergence* automatically adjusts the TV's tubes; *Red convergence* displays the Red convergence screen, allowing you to use the arrow buttons to align the red and green images; *Blue convergence* displays the Blue convergence screen, allowing you to use the arrow buttons to align the blue and green images.

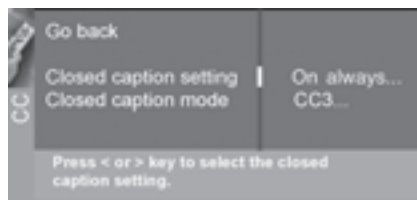
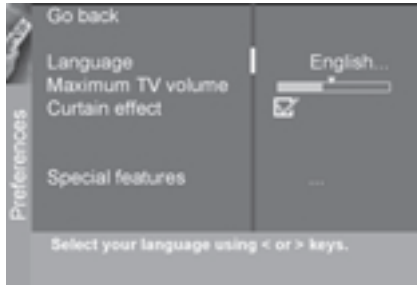

Chapter 7: Information Displays

Using the Info Display

Your TV/DVD gives you many options when playing different types of discs. You can access these features through the on-screen Info Display.

To access the Info Display while a disc is playing, press INFO on the remote. The Info Display appears across the top of the screen. Each of the playback features is represented by an icon. To access a feature, use the arrow buttons on the remote to highlight the icon. Each feature that can be accessed from the On-Screen Info Display is described on the following pages. To clear the Info Display from the screen, press INFO on the remote control.

Audio CD Info Display

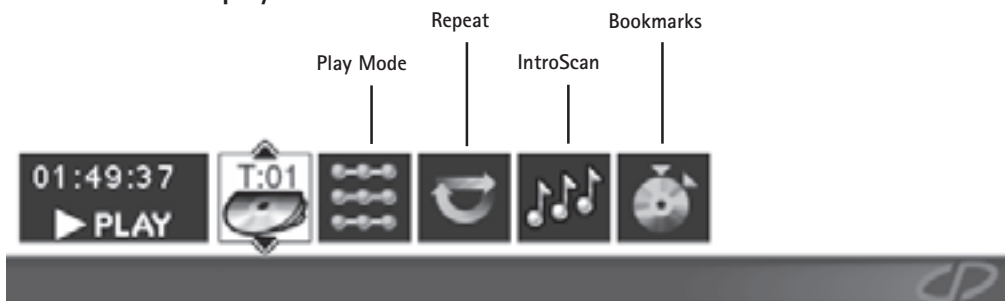

MP3 Info Display

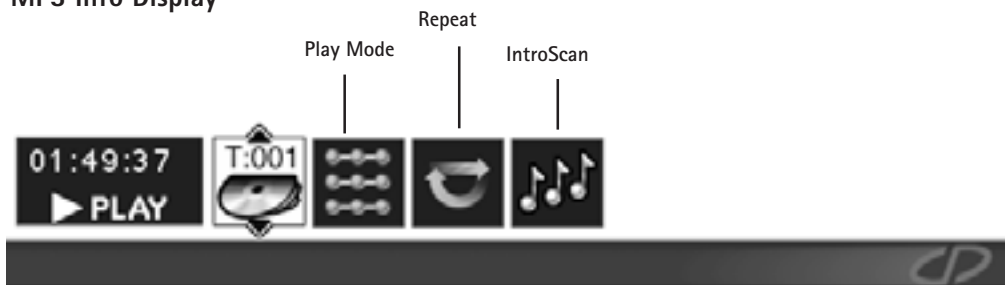

Video CD Info Display

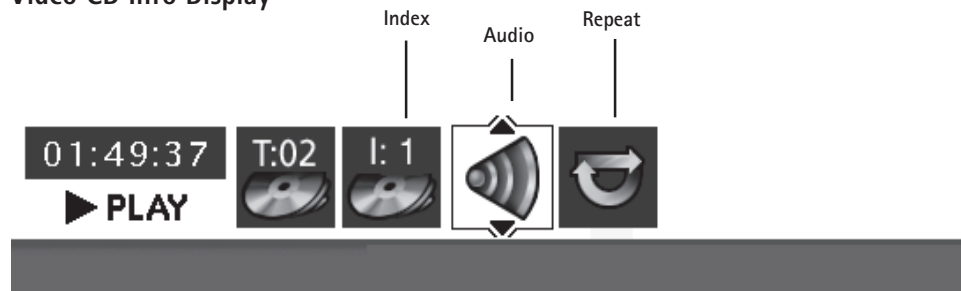

Using the Time Display

The Clock part of the Info Display shows the current disc time. To see the current disc time:

1. Press INFO on the remote (the Info Display appears).
2. Highlight the *Clock* icon. Press OK. The amount of time the track has played appears in the time window.
3. Press INFO to clear the screen.



Selecting a Specific Track

1. Press INFO on the remote.
2. Highlight the *Track* icon.
3. Use the number buttons on the remote to enter the track number you want to play, or use the up/down arrow buttons to scroll through the track numbers. You may need to press the OK button on the remote after you enter a single digit track number.



Selecting a Specific Index (Available only on Video CDs)

1. Press INFO on the remote.
2. Highlight the *Index* icon from the Info Display.
3. Use the number button(s) on the remote to enter the index number you want to play, or use the up/down arrows to scroll through the index numbers. When a new index number is entered, that index will begin playing.



Selecting a Play Mode (Available only on Audio CDs and MP3s)

The Play Mode feature lets you set up the order in which you want the tracks on the disc to play. There are three options:

Standard: the tracks play in the order listed on the CD (starting with track 1). MP3 files are listed in the order they were recorded.

Random: the tracks on the disc play in random order.

Program: the tracks on the disc play in the order you've programmed. You must first create a program list in the *Play* menu of the DVD's main menu.

Switching between Standard and Random Play

Standard (the order listed on the disc) is the default setting for the DVD mode. To change the default setting:

1. Press INFO on the remote while a disc is playing. The Info Display appears.
2. Highlight the *Play Mode* icon. The current play mode appears in the text box underneath the icons. Press the up/down arrow buttons to scroll through the play mode choices until Random appears in the text box. The tracks on the disc will now play in random order.

Note: The TV/DVD defaults to Standard playback whenever you put a new disc into your TV/DVD.

Using the Program Play Feature

To use the Program Play feature, you must enter the order in which you want the tracks on the CD or MP3 to play by creating a program. This is done from the DVD's main menu.

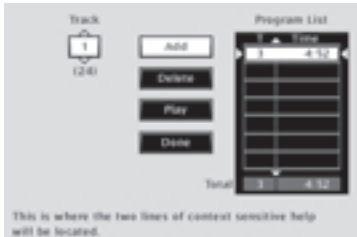

This is where the two lines of context sensitive help will be located.

Use the Edit Program screen to create your own playlist.

To edit a CD:

1. If the disc is playing, press STOP to stop playback (the DVD's main menu appears).
2. Highlight *Play Mode* and press OK (the *Play Mode* menu appears).
3. Highlight *Edit Program* and press OK (the *Edit Program* screen appears).
4. The *Track* box is highlighted. Use the number buttons on the remote to enter the track you want to play first. The track number you entered appears in the *Track* box and the cursor highlights *Add*.
5. Press OK to add that track to the *Program List*. The cursor jumps to the next spot in the *Program List* section. Make sure the *Track* box is highlighted and enter your next track.
6. Continue adding tracks as explained in steps 4–5 until your program is complete. You can play your program by highlighting *Play* and pressing OK, or you can save the program by highlighting *Done* and pressing OK. If you save the program, you can select it from the Info Display. The program will be erased when you remove the disc from the disc tray or the TV/DVD is turned off.

To edit a MP3:

1. If the disc is playing, press STOP to stop playback (the DVD's main menu appears).
2. Highlight *Play Mode* and press OK (the *Play Mode* menu appears).
3. Highlight *Edit Program* and press OK (the *Edit Program* screen appears).
4. The *Standard Playlist* box is highlighted. Use the up/down arrow buttons on the remote to enter the track you want to play first.
5. Highlight *Add* to add that track to the *Program List* and press OK.
6. Continue adding tracks as explained in steps 4–5 until your program is complete. You can play your program by highlighting *Play* and pressing OK, or you can save the program by highlighting *Done* and pressing OK. If you save the program, you can select it from the Info Display. The program will be erased when you remove the disc from the disc tray or the TV/DVD is turned off.

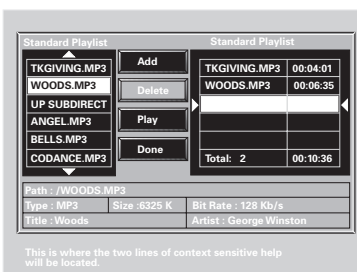

This is where the two lines of context sensitive help will be located.

Editing a Playlist

1. If the disc is playing, press STOP to stop playback. The DVD's main menu appears.
2. Highlight *Play Mode* and press OK (the *Play Mode* menu appears).
3. Highlight *Edit Program* and press OK (the *Edit Program* screen appears).
4. Highlight the item in the playlist you want to delete.
5. Highlight *Delete*, and press OK.
6. When you've rearranged the playlist and/or deleted all the tracks necessary, press OK.



Using the Repeat Feature

The default mode for the Repeat feature is Off. There are three Repeat options for Audio CDs:

- Disc – repeats the disc that is playing
- Track – repeats the track that is playing
- A•B – Set the beginning (point A) and the end (point B) to make this part of the CD play repeatedly.

To Use Repeat:

1. While a disc is playing, press INFO on the remote to bring up the Info Display.
2. Highlight the *Repeat* icon. The text in the text box below the icons will read *Repeat Mode: Off*.
3. Press the up/down arrow buttons to scroll through the *Repeat* options until the Repeat option you want is displayed in the text box.
4. Press OK. The selected repeat option will loop repeatedly until you turn Repeat off. Repeat is turned off by completing steps 1 through 3 above, and selecting the Off option.

A•B Repeat (Available only on Audio CDs)

A•B Repeat lets you define a specific segment on the disc that you want to repeat:

1. Find the spot on the disc that is a few seconds before the beginning of the part you want to repeat (this gives you time to access the Info Display and the Repeat feature).
2. Press INFO on the remote and select the *Repeat* icon from the Info Display.
3. Press the up/down arrow buttons until the A•B Repeat option is shown in the text box underneath the icons. The text box reads *Repeat Mode: A-B Press OK to Set A Point*.
4. At the beginning of the part you want to repeat, press OK to set the A point.
5. When you get to the part of the disc that you want to be the end of the repeated segment (the B point), press OK. The segment will repeat until you turn Repeat off.
6. To make the Info Display disappear from the screen, press the INFO button on the remote.

How to Cancel Repeat

There are three ways to cancel Repeat:

- Press STOP twice.
- Go to the *Repeat* icon in the Info Display and select *Off*.
- Eject the disc.

Changing the Audio Channel Output (Available only on Video CDs)

If you are playing a stereo Video CD, you can change the channel output.

1. Press INFO on the remote to bring up the Info Display.
2. Highlight the *Audio Channel* icon on the Info Display.
3. The audio channel choices appear in the text box. Use the up/down arrow keys to scroll through the choices: *Stereo, Left, Right or Mono*. Whatever choice is displayed becomes the active choice.

Using IntroScan (Available only on Audio CDs and MP3s)

IntroScan plays the first ten seconds of each track on the CD (similar to the scan feature that's on many car radios). To use IntroScan:

1. Press INFO on the remote (the Info Display appears).
2. Highlight the *IntroScan* icon. Press OK. The first ten seconds of each track will play.
 - After IntroScan goes through all of the tracks, it stops.
 - If you want to stop IntroScan while it's in progress, press PLAY on the remote. The current track starts playing in its entirety.
 - You can also access IntroScan from the *Play Mode* menu in the DVD's main menu.

Using Bookmarks (Available only on Audio CDs)

To store, use and clear bookmarks, go to page 21. The instructions are the same.

Dub Assist (Available only on Audio CDs)

Dub Assist helps you record a CD onto an audio cassette tape by determining the number of tracks that will fit on one side of the tape so you have time to turn the tape over to record on the other side. Dub Assist does not have an icon on the Info Display bar. It is activated through the DVD's *Play* menu.

To use Dub Assist when you're recording a CD onto an audio cassette:

1. Press STOP if a CD is playing (the DVD's main menu appears).
2. Highlight *Play Mode* and press OK (the *Play Mode* options appear).
3. Highlight *Dub Assist* and press OK (the *Dub Assist* screen appears).
4. The highlight should be in the *Play Order* window. Choose *Standard*, *Optimized*, or *Program*.



Use the Dub Assist screen to determine how many CD tracks can fit on a cassette.

Standard: This is the default mode. The tracks are recorded in the order on the CD (track 1 is recorded first, track 2 second, etc.)

Optimized: The tracks are recorded in the order that optimizes the number of tracks that can fit on one side of the audio cassette so you have the least amount of dead space at the end of the tape.

Program: The tracks are recorded in the order you program. You must create your program in the *Edit Program* menu that's in the DVD's *Play* menu.

5. Use the arrow keys to highlight the *Segment Length* box. When the *Segment Length* box is highlighted, use the up/down arrow buttons to enter the length of one side of the audio cassette.
6. The order the tracks will be recorded in appears in the *Segment Length* box. Use the arrow keys to highlight the *Start* box and press OK.
7. Follow the instructions on the screen to begin recording.

Chapter 8: Other Information

Troubleshooting

Most problems you encounter with your TV can be corrected by consulting the following troubleshooting list.

Note: If you prefer, we can provide you with the name of an Authorized Service Representative who will visit your home for a fee to install your electronic entertainment system and to instruct you in its operation. For details about this service, call 1-888-206-3359 or visit rcascenium.com.

DVD Problems

Player won't work

- Reset the TV/DVD by unplugging the AC power cord and plugging it back in.

Disc won't play

- Insert a disc with the label side facing up.
- Check the type of disc you put into the disc tray. This TV/DVD only plays DVD video discs, Video CDs, audio CDs and MP3s.
- If the disc is a DTS music CD, it requires a DTS decoder. If you have a DTS receiver hooked up to your TV/DVD and you are still not getting sound, make sure the sound is set correctly (see Chapter 5).
- Both the TV/DVD and the disc are coded by region. If the regional codes don't match, the disc can't be played. This TV/DVD is Region No. 1.

Play starts, but then stops immediately

- The disc is dirty. Clean it.
- Condensation has formed. Allow player to dry out.

No sound or distorted sound

- Make sure your TV/DVD is connected properly. Make sure all cables are securely inserted into the appropriate jacks.
- You may need to readjust the *Digital Output* settings from the *Sound* menu (see Chapter 5).
- Sound is muted during still, frame advance, or slow-motion play.
- If you connected an audio or audio/video receiver to your TV/DVD, make sure you chose the correct input setting on the receiver.

Can't advance through a movie

- You can't advance through the opening credits and warning information that appear at the beginning of movies because the disc is programmed to prohibit that action.

The icon appears on screen

- The feature or action cannot be completed at this time because:
 1. The disc's software restricts it.
 2. The disc's software doesn't support that feature (e.g., angles).
 3. The feature is not available at the moment.
 4. You've requested a title or chapter number that is out of range.

The picture is distorted

- The disc might be damaged. Try another disc.

Picture is distorted during forward and reverse scan

- It is normal for some distortion to appear while scanning.

A screen saver appears on the screen

- Your TV/DVD is equipped with a screen saver that appears on the screen after the DVD mode has been idle for several minutes. Press STOP or GO BACK on the remote to make the screen saver disappear from the screen and return to the DVD's main menu.

Subtitle and/or audio language is not the one selected from the initial setting

- If the subtitle and/or audio language does not exist on the disc, the initial settings will not be seen/heard. The disc's priority language is selected instead. Set the subtitle and/or audio language manually through the Info Display or the DVD's main menu.

The menu is displayed in a foreign language

- The Menu Language preference is set to that language. From the DVD's main menu, select the *Languages option* (In Spanish, shown as *Idiomas*; in French, as *Langues*). From the Languages menu, select the *Player Menus* option (In Spanish, shown as *Menús del Lector*; in French, as *Menus Lecteur*). Highlight the language you prefer and press OK.

No forward or reverse scan

- Some discs have sections that prohibit rapid scanning, or title and chapter skip.
- If you're trying to skip through the warning information and credits at the beginning of a movie, you won't be able to. This part of the movie is often programmed to prohibit skipping through it.

Camera angle cannot be changed

- Some discs don't have the multi-camera angle system, and some discs only have it in certain parts of the movie.

Picture is too tall and thin

- Change the aspect ratio using the *TV Image* setting in the Display menu (see Chapter 5).

Picture is too short and wide

- Change the aspect ratio using the *TV Image* setting in the Display menu (see Chapter 5).

Cannot copy discs to video tape

- You can't record DVD discs onto videocassettes because the discs are encoded with anti-copy protection.

Full Version of Disc Does Not Play

- The DVD might be locked. To unlock see Chapter 5.

Disc won't eject

- When you put a disc into the disc tray, it may take up to 15 seconds to read the disc. You won't be able to eject the disc during this time. Wait 15 seconds and try again.

I don't remember my password and I want to unlock the DVD

- If you forget your password, simultaneously press and hold OPEN/CLOSE and STOP on the TV/DVD's front panel for 3 seconds. Enter a new password via the *Lock* menu.

TV Problems

TV won't turn on

- Press the TV button.
- Make sure the TV is plugged in.
- Check the wall receptacle (or extension cord) to make sure it is "live" by plugging in something else.
- Something might be wrong with your remote control. Press the POWER button on the front of the TV. If the TV turns on, check the remote control solutions on page 43.
- The front panel controls may be locked (disabled). Use the remote control to unlock the front panel controls by selecting the *Front Panel Block* in the *Parental Control* menu and press OK to uncheck the box.

Buttons don't work

- If you're using the remote control, press the TV button first to make sure the remote is in TV mode.
- The front panel controls may be locked (disabled). Use the remote control to unlock the front panel controls by selecting the *Front Panel Block* in the *Parental Control* menu and press OK to uncheck the box.
- Unplug the TV for two minutes and then plug it back in. Turn the TV on and try again.

TV turns off while playing

- Sleep timer may have been activated. Go to page 34 for instructions.
- Electronic protection circuit may have been activated because of a power surge. Wait 30 seconds and then turn on again. If this happens frequently, the voltage in your house may be abnormally high or low.
- Unplug. Wait five minutes. Plug in again.

TV turns on unexpectedly

- Wake up timer might have been activated. Go to page 34 for instructions.
- Auto on might have been activated. Go to page 34 for instructions.
- You might have pressed CH+, CH- or INPUT on the remote accidentally.

Blank screen

- Make sure the component connected to the TV is turned on.
- Try another channel.

No sound, picture okay

- Maybe the sound is muted. Try pressing the volume up button to restore sound.
- If using S-Video or Y, P_B, P_R, remember to also connect the component's left and right audio output jacks to the TV's L/MONO and R Audio Input jacks.
- Make sure the INT/EXT switch on the back of the TV is put on "INT".
- The sound settings may not be set correctly. Go to page 33 for more information.

Can't select certain channel

- Channel may be blocked or not approved in the *Parental Controls* menu.
- If using a VCR, check to make sure the TV/VCR button on the VCR is in the correct mode (press the TV/VCR button on your VCR).

Noisy stereo reception

- May be a weak station. Use Sound menu to choose *mono* sound.

No picture/blue screen, no sound but TV is on

- Maybe the cable/air function is set to the wrong position. Go to page 35 for detailed instructions.
- The channel might be blank – change channels.
- If you're watching your VCR and it's connected with coaxial cable to the CABLE/ANTENNA jack, tune the TV to channel 3 or 4 (whichever channel is selected on the 3/4 switch on the back of your VCR). Also check to make sure the TV/VCR button on the VCR is in the correct mode (press the TV/VCR button on your VCR).

Sound okay, picture poor

- Check antenna connections. Make sure all of the cables are firmly connected to the jacks.
- Try adjusting sharpness function to improve weak signals. Go to page 34 for more instructions.

Volume buttons not adjusting volume louder

- Check to make sure volume isn't limited by the maximum volume feature. Go to page 35 for more instructions.

Picture not moving

- You have activated the Freeze feature by pressing OK on the remote. Press any button to "unfreeze" the picture.

Black box appears on the screen

- Closed-captioning might be on. Check *Closed Caption* in the *Setup* menu. Go to page 35 for more instructions.

Freeze not working

- The freeze feature is not available for Component video (CMP1 or CMP2) or DVI inputs.

Low battery warning appears on screen

- Place new batteries in remote.

The Remote Control Doesn't Work

- Something might be between the remote and the remote sensor on the component. Make sure there is a clear path.
- Maybe the remote isn't aimed directly at the component (TV or VCR) that you're trying to operate.
- Maybe remote is not in TV Mode. Press the TV button so remote will control TV.
- Maybe batteries in remote are weak, dead, or installed incorrectly. Put new batteries in the remote. (Note, if you remove the batteries, you may have to reprogram the remote to operate other components.)
- You might need to drain the remote's microprocessor: remove batteries and press the number 1 button for at least 60 seconds. Release the 1 button, replace the batteries, and (if necessary) program the remote again.

Problems with V-Chip/Parental Controls

The rating limits don't work

- You must lock the settings. Go to the *MAIN MENU* (press MENU on your remote), select *Parental Control*, select *Lock Parental Controls*.

I don't remember my password and I want to unlock the TV

- If you forget your password, press MENU, then select *Parental Control* (the password entry screen appears). Simultaneously press and hold CH+ and VOL+ on the TV's front panel for 3 seconds. The Parental control menu appears on the screen, and you can re-enter a password via *Lock Parental Controls*.

The V-Chip won't let me watch a program even though it's not rated as violent.

- Maybe the movie was given an NR (Not Rated) status. After you block movie ratings, you must set *NR* to *View* separately in order to view movies with an NR rating.

Care and Cleaning

CAUTION: Turn OFF your TV/DVD before cleaning.

You can clean the TV/DVD as required, using a soft lint-free cloth. Be sure to occasionally dust the ventilation slots in the cabinet to help assure adequate ventilation.

The TV/DVD's screen may be cleaned with a soft, lint-free cloth as well. Take care not to scratch or mar the screen. If necessary, you may use a cloth dampened with warm water. Never use strong cleaning agents, such as ammonia-based cleaners, or abrasive powder. These types of cleaners will damage the TV/DVD.

While cleaning do not spray liquid directly on the screen, or allow liquid to run down the screen and inside the TV/DVD. Also, avoid placing drinks or vases with water on top of the TV/DVD. This could increase the risk of fire or shock hazard or damage to the TV/DVD.

Caution: Using video games or any external accessory with fixed images for extended periods of time can cause them to be permanently imprinted on the picture tube (or projection TV picture tubes). ALSO, some network/program logos, phone numbers, etc. may cause similar damage. This damage is not covered by your warranty.

Handling Cautions

- Before connecting other components to this TV/DVD, be sure to turn all components off.
- Don't move the TV/DVD while a disc is being played. The disc may get scratched or broken, and the TV/DVD's internal parts may be damaged.
- Don't put any container filled with liquid or any small metal objects on the TV/DVD.
- Be careful not to put your hand into the disc tray.
- Don't place anything other than the disc in the disc tray.
- Exterior influences such as lightning and static electricity can affect normal operation of this player. If this occurs, turn the TV/DVD off and on again with the ON•OFF button, or disconnect and then reconnect the AC power cord to the AC power outlet. The TV/DVD will operate normally.
- Be sure to remove the disc and turn off the TV/DVD after use.

Formation of Condensation

- Due to sharp changes in temperature and humidity, condensation may form if warm air comes in contact with any cold parts inside the TV/DVD.
- When condensation forms inside the TV/DVD, it may not operate correctly. If this occurs, leave the TV/DVD at room temperature until the inside of the disc tray becomes dry and operational.
- If condensation forms on a disc, wipe the disc with a soft, dry cloth by moving the cloth from the center hole toward the outer edge.

Other Information

Limited Warranty

What your warranty covers:

- Defects in materials or workmanship.

For how long after your purchase:

- One year from date of purchase for labor.
- One year from date of purchase for parts.
- Two years from date of purchase for the picture tube.

The warranty period for rental units begins with the first rental or 45 days from date of shipment to the rental firm, whichever comes first.

What we will do:

- Pay an Authorized Service Center the labor charges to repair your unit.
- Pay an Authorized Service Center for the new, or at our option, refurbished replacement parts and picture tube required to repair your unit.

How you get service:

- Call 1-866-SCENIUM and have your unit's date of purchase and model number ready.
- A representative will troubleshoot your problem over the phone.
- If the representative determines that you should receive service, they will provide you with the name(s) of the Authorized Service Center in your area.
- Contact the Service Center and arrange for home or pick up, repair, and return service, provided that your unit is located within the geographic territory covered by an Authorized Service Center. If not, you must take your unit to the Service Center location at your own expense, or pay for the cost the Service Center may charge to transport your unit to and from your home.
- Proof of purchase in the form of a bill of sale or receipted invoice which is evidence that the product is within the warranty period must be presented to obtain warranty service. For rental firms, proof of first rental is also required.

What your warranty does not cover:

- Customer instruction. (Your Owner's Manual describes how to install, adjust, and operate your unit. Any additional information should be obtained from your dealer.)
- Installation and related adjustments.
- Signal reception problems not caused by your unit.
- Damage from misuse or neglect.
- Batteries.
- Damage from images burnt onto the screen.
- A unit that has been modified or incorporated into other products.
- A unit purchased or serviced outside the U.S.A.
- Acts of nature, such as but not limited to lightning damage.

Product registration:

- Please complete and mail the Product Registration Card packed with your unit. It will make it easier to contact you should it ever be necessary. The return of the card is not required for warranty coverage.

Limitation of Warranty:

- THE WARRANTY STATED ABOVE IS THE ONLY WARRANTY APPLICABLE TO THIS PRODUCT. ALL OTHER WARRANTIES, EXPRESS OR IMPLIED (INCLUDING ALL IMPLIED WARRANTIES OF MERCHANTABILITY OR FITNESS FOR A PARTICULAR PURPOSE) ARE HEREBY DISCLAIMED. NO VERBAL OR WRITTEN INFORMATION GIVEN BY THOMSON MULTIMEDIA INC., ITS AGENTS OR EMPLOYEES SHALL CREATE A WARRANTY OR IN ANY WAY INCREASE THE SCOPE OF THIS WARRANTY.
- REPAIR OR REPLACEMENT AS PROVIDED UNDER THIS WARRANTY IS THE EXCLUSIVE REMEDY OF THE CONSUMER. THOMSON MULTIMEDIA INC. SHALL NOT BE LIABLE FOR INCIDENTAL OR CONSEQUENTIAL DAMAGES RESULTING FROM THE USE OF THIS PRODUCT OR ARISING OUT OF ANY BREACH OF ANY EXPRESS OR IMPLIED WARRANTY ON THIS PRODUCT. THIS DISCLAIMER OF WARRANTIES AND LIMITED WARRANTY ARE GOVERNED BY THE LAWS OF THE STATE OF INDIANA. EXCEPT TO THE EXTENT PROHIBITED BY APPLICABLE LAW, ANY IMPLIED WARRANTY OF MERCHANTABILITY OR FITNESS FOR A PARTICULAR PURPOSE ON THIS PRODUCT IS LIMITED TO THE APPLICABLE WARRANTY PERIOD SET FORTH ABOVE.

How State Law relates to this warranty:

- Some states do not allow the exclusion nor limitation of incidental or consequential damages, or limitations on how long an implied warranty lasts, so the above limitations or exclusions may not apply to you.
- This warranty gives you specific legal rights, and you also may have other rights that vary from state to state.

If you purchased your television outside the United States:

- This warranty does not apply. Contact your dealer for warranty information.

Service calls which do not involve defective materials or workmanship are not covered by this warranty. Costs of such service calls are the sole responsibility of the purchaser.

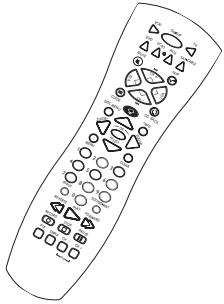

RCR160TALM1

Remote Control This is the remote control that came packed with your TV. Replacements or spares can be ordered as needed.

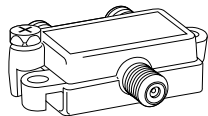

Splitter
VH47

2-way Signal Splitter helps you connect to a second TV or VCR.

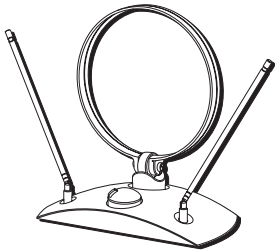

ANT200

Amplified VHF/UHF/FM Antenna allows you to easily switch from the antenna signal to cable or satellite easily without disconnecting antenna.

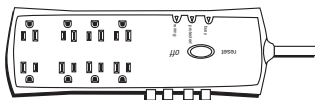

SCTV 160

Surge Protector provides eight outlets, coaxial and telephoneline protection. Audible alarm for surge failure.

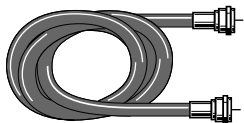

VH81 (3-ft)
VH82 (6-ft)

Screw-on Cable attaches to the round antenna connectors (called 75-ohm F-type) on the back of your VCR or TV. The ends screw onto the connectors for a secure connection.



VH83

Standard Audio/Video cable with RCA-type phono plugs.



VH913

S-Video Cable has multi-pin connectors on each end for connecting S-Video components to your TV.

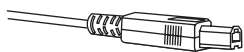

Optical cable
DV3 (3-ft), DV6 (6-ft)

Optical cable Helps you connect to a component with an Optical Digital Audio In jack, such as a Dolby Digital decoder or receiver.

Accessory Order Form

Description	Part No.	Price	Qty	Total
Screw-on antenna cable (3-ft)	VH81	\$3.95		
Screw-on antenna cable (6-ft)	VH82	\$4.95		
Push-on antenna cable (6-ft)	VH89	\$5.95		
Monaural VCR Dubbing Cable (6-ft)	VH83	\$5.95		
Stereo VCR Dubbing Cable (6-ft)	VH84	\$9.95		
S-Video Cable (6-ft)	VH976	\$7.95		
S-Video Cable (12-ft)	VH913	\$14.95		
2-way Signal Splitter	VH47	\$3.95		
Amplified Antenna	ANT200	\$49.95		
Remote Control (RCR160TALM1)	257003	\$33.15		
Audio•Video Adapter	228449	\$4.45		
Surge Protector	SCTV160	\$49.95		
Component Video Cables (6-ft)	DT6DC	\$24.95		
Component Video Cables (12-ft)	DT12DC	\$34.95		
Optical Cable (3-ft)	DV3	\$15.95		
Optical Cable (6-ft)	DV6	\$19.95		

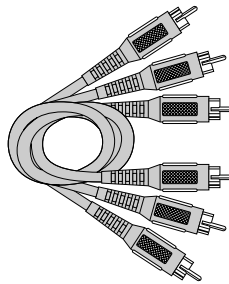

Gold-Tipped cable
DT6DC (6-ft)
DT12DC (12-ft)

Component Video Cables Triple cable used to connect a video source with Y, P_R, P_B jacks to the TV.

HOW TO ORDER

BY PHONE: To place your order by phone, have your Visa, MasterCard or Discover Card ready and call **1-800-338-0376**

Use this number only to place an order for accessory items listed on this order form.

BY MAIL: mail money order or check in US currency (made payable to Thomson multimedia Inc.) to the following address:

Video Accessories
PO Box 8419
Ronks, PA 17573

Visit the RCA Scenium website at www.rcascenium.com

Please do not send any products to the Indianapolis address listed in this manual or on the carton. This will only add delays in service for your product.

Thomson multimedia Inc.
10330 North Meridian Street
Indianapolis, IN 46290

©2002 Thomson multimedia Inc.
Trademark(s)® Registered
Marca(s) Registrada(s)
Printed in USA
TOCOM 15891740

